

REVISIONS

SYMBOL	DESCRIPTION	DATE	APPROVAL
D	RN A050 Incorporated Pages 1 and 6 changed	9/21/92	

SHEET REVISION STATUS

SH	1	2	3	4	5	6	7	8	9	10	11	12	13	14	15	16	17	18	19	20
REV	D	C	C	C	C	D	C	C	C	C	C	C	C	C	C	C	C	C	C	C
SH	21	22	23	24	25	26	27	28	29	30	31	32	33	34	35	36	37	38	39	40
REV	A	A	A	A	A	A	A	A	A	A	A	A	A	A	A	A	A	A	A	A
SH	41	42	43	44	45	46	47	48	49	50	51	52	53	54	55	56	57	58	59	60
REV	A																			

ORIGINATOR Stephan Naus/GSFC	DATE 8/27/91	FSC: 5935
APPROVED Walter B. Thomas/GSFC	8/28/91	Connectors, Electrical, Rectangular, Miniature, Polarized Shell, Rack and Panel, for Space Flight Use
CODE 311 APPROVAL Stephan Naus	8/27/91	
CODE 311 SUPERVISORY APVL George Kramer	8/28/91	
ADDITIONAL APPROVAL INITIAL RELEASE	2/69	S-311-P-10

NATIONAL AERONAUTICS AND SPACE ADMINISTRATION
GODDARD SPACE FLIGHT CENTER
GREENBELT, MARYLAND 20771

CAGE CODE: 25306

PAGE 1 OF 41

1. SCOPE.

1.1 Purpose. This specification delineates the general provisions for multi-contact electrical connectors utilizing solder-type non-removable contacts and in combination with coaxial and/or high voltage contacts. These connectors are intended for space flight use at Goddard Space Flight Center (GSFC).

1.2 Type designation. The connectors shall be of the following type designations, and shall be ordered by these designation only.

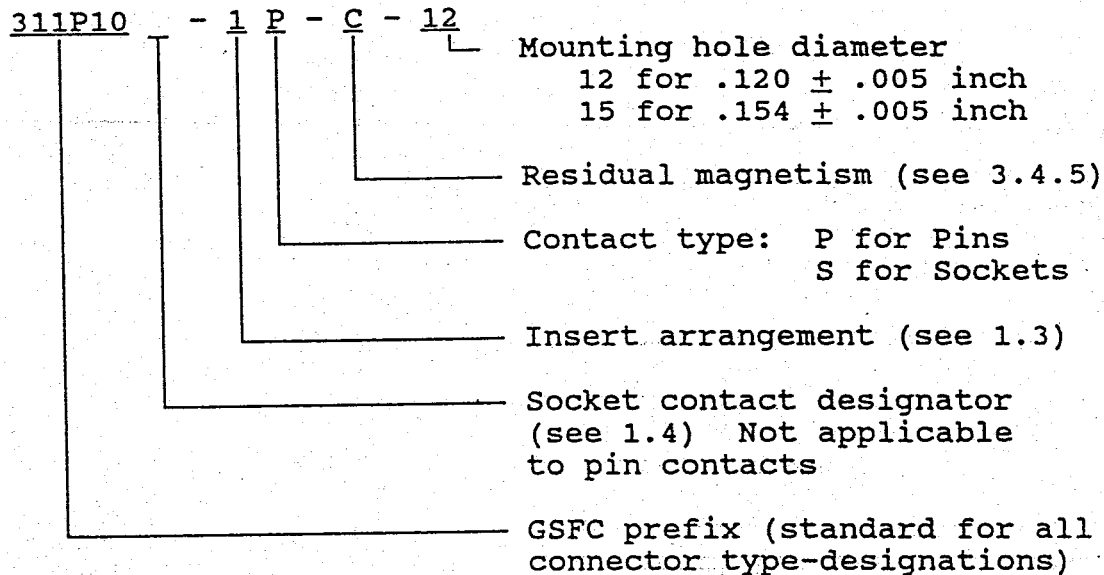

1.3 Contact arrangement. Contact arrangements shall be in accordance with Table II and Figures 2-21.

1.4 Socket contacts. Socket contacts, supplied to the designation illustrated above, are equipped with contact (napkin) springs. The addition of the letter B to the type designation indicates a socket contact connector supplied with split finger-sleeved contacts. Connectors bearing the split finger-sleeved contacts may be supplied in lieu of connectors bearing no socket contact designation, providing all requirements of this specification are met. A connector bearing no socket contact designator shall not be supplied for connectors bearing the B socket contact designator.

2. APPLICABLE DOCUMENTS.

2.1 Documents. The following documents, of the issue in effect on the date of invitation for bids or request for proposal, form a part of this specification to the extent specified herein. A later revision of a specification may be used, as long as, the later revision does not degrade the specification requirements.

Specifications

MIL-C-24308	Connectors, Electrical, Rectangular, Miniature, Polarized Shell, Rack and Panel, General Specification for
MIL-C-39029	Contacts, Electrical Connector, General Specification for
MIL-I-45208	Inspection System Requirements
MIL-C-55330	Connectors, Electrical and Fiber Optics, Packaging of
SD-6	Provisions Governing Qualification

Standards

MIL-STD-105	Sampling Procedure and Tables for Inspection by Attributes
MIL-STD-1344	Test Methods for Electrical Connectors
MS18268	Connectors, Electrical, Rectangular, Miniature, Polarized Shell, Rack and Panel, Shell, Receptacle, Socket Contacts, Solder Type
MS18269	Connectors, Electrical, Rectangular, Miniature, Polarized Shell, Rack and Panel, Shell, Receptacle, Socket Contacts, Solder Type
MS18281	Contacts, Pin and Sockets, Solder Type, Non-removable
MS18273	Insert Arrangement, Electrical Connector Shell Size 1

MS18274	Insert Arrangement, Electrical Connector Shell Size 2
MS18275	Insert Arrangement, Electrical Connector Shell Size 3
MS18276	Insert Arrangement, Electrical Connector Shell Size 4
MS18277	Insert Arrangement, Electrical Connector Shell Size 5

Other Publications

ASTM E595	Material from Outgassing in a Vacuum Environment, Standard Test Method for
S-311-P-4/06	Contacts, Electrical, Coaxial, for Subminiature, Rectangular Connectors

2.2 Order of precedence. In the event of conflict between the text of this specification and references cited herein, the text of this specification shall take precedence. Nothing in this document, however, supersedes applicable laws and regulations unless a specific exemption has been granted.

2.3 Copies of documents. Copies of federal and military documents may be obtained from the Standardization Document Order Desk, 700 Robbins Avenue, Building #4-Section D, Philadelphia, PA 19111-5094. Copies of ASTM publications are available from the American Society for Testing and Materials, 1916 Race Street, Philadelphia, PA 19103.

3. REQUIREMENTS

3.1 General. The general requirements of MIL-C-24308 shall be met. In addition, individual connectors and contacts requirements shall meet the requirements of this specification.

3.2 Qualification. The individual connectors and contacts furnished under this specification shall be product which have been granted qualification approval by NASA/GSFC. Qualification approval shall be based on the following.

3.2.1 Application for qualification. Each application shall be made in accordance with SD-6, Provisions Governing Qualification. All applications shall be submitted to the activity listed below:

NASA/GSFC
Greenbelt, MD 20771

Attn: QPLD Administrator
Code 311.2

- 3.2.2 Design and source approval. Before qualification, the manufacturer's facilities shall be subjected to survey (at the option of GSFC) by the Office of Flight Assurance, GSFC. Compliance with MIL-I-45208 is required. In addition the history and detailed engineering of the specific connector design will be reviewed, as will the documented manufacturing and quality control procedures. Only those sources approved in the design and source approval phase shall be eligible for qualification or award of contract under this specification. Source approval and design approval do not constitute part qualification or an equivalent thereof.
- 3.2.3 Part qualification. The individual connectors and contacts shall be product which have passed the qualification inspection requirements of MIL-C-24308. Additionally, the connector and contacts shall pass the requirements cited herein.
- 3.2.4 Regualification. Regualification shall be imposed following any changes in design, manufacture, materials or quality control procedures as reviewed and approved during qualification. Regualification shall be required if it is demonstrated that any stipulations intially presented in the manufacturer's certification no longer apply. Inspection discrepancies which are not suitably explained by analysis, or by other means, shall be considered a basis for disqualification by GSFC.
- 3.3 Design and construction. The design and construction requirements shall be in accordance with MIL-C-24308, except as specified herein.
- 3.3.1 Materials. Materials shall be in accordance with MIL-C-24308, except as specified herein.
- 3.3.1.1 Nonmagnetic material. All parts used in the connectors and contacts shall be made from materials which are classed as nonmagnetic (see 3.4.5).

3.3.1.2 Sublimate materials. Cadmium and other materials that sublimate in a hard vacuum shall not be used.

3.3.1.3 Shell material and finish. The shell shall be made of brass in accordance with ASTM B-19 or ASTM B-36. The shell finish shall be gold plate in accordance with MIL-G-45204, Type II, Grade C, Class 1 over copper flash in accordance with MIL-C-14550.

3.3.2 Contacts.

3.3.2.1 Size 20. The size 20 contacts shall meet the dimensional requirements of MS18281. Contact solder cup shall not be pre-tinned or prefilled with solder.

3.3.2.2 High voltage. The high voltage contacts shall meet the requirements of S-311-P-4/06. Center contacts shall be captive.

3.3.2.3 Coaxial. Coaxial contacts shall be in accordance with S-311-P-4/06.

3.4 Performance. The requirements of MIL-C-24308 shall be met, except as specified herein.

3.4.1 Dielectric Withstanding Voltage. When tested in accordance with 4.5.1, there shall be no evidence of damage, arcing, or breakdown. The applicable test voltages are specified below:

	AC Volts (rms) 60 Hz			
	Sea Level		70K feet	
	Straight	90	Straight	90
Size 20 contact (between contacts and to shell)	1000	NA	325	NA
High voltage to nearest size 20 contact and shell	2800	2800	475	475
Coaxial outer contact to shell	1000	1000	325	325
Coaxial outer contact to nearest size 20 contact	1000	NA	425	NA
Coaxial outer contact to center contact	1000	800	325	275

3.4.2 Connector mating and unmating forces. When tested in accordance with 4.5.2, the forces to mate and unmate the connectors shall be as specified below:

Contact Arrangement	Force in pounds (maximum)	
	Mating	Unmating
All size 20	per MIL-C-24308	per MIL-C-24308
Coaxial in combination	per MIL-C-24308 plus 1.5 times the number of coaxial contacts	per MIL-C-24308 plus 1.25 times the number of coaxial contacts
High Voltage combination	per MIL-C-24308 plus .75 times the number of HV contacts	per MIL-C-24308 plus .5 times the number of HV contacts

3.4.3 Contact engagement and separation forces. When tested in accordance with 4.5.3, the contact engagement and separation forces shall meet the following requirements:

- a. Size 20 contacts shall meet the requirements of MIL-C-24308.
- b. Coaxial and high voltage contacts shall meet the requirements specified below:

	Engaging		Separating	
	Minimum	Maximum	Minimum	Maximum
Coaxial	3 oz.	24 oz.	3 oz.	20 oz.
High Voltage	1 oz.	12 oz.	1 oz.	8 oz.

3.4.4 Contact retention. When tested in accordance with 4.5.4, the axial displacement of the contact shall not exceed .012 inch while under the specified loads. For size 20 contacts a nine (9) pound force shall be applied to the contact. For coaxial and high voltage contacts a fifteen (15) pound force shall be applied to the contact.

3.4.5 Residual magnetism. When tested in accordance with 4.5.5, the residual magnetism of fully assembled connectors shall not exceed the limits for residual magnetism as specified below:

<u>Level</u>	<u>Residual Magnetism (gamma)</u>
A	2000
B	200
C	20

3.4.6 Outgassing. When tested in accordance with 4.5.6 the material shall meet the requirements of MIL-C-24308.

3.5 Part marking. Connectors shall be marked in accordance with MIL-C-24308, except the GSFC type designation as identified in section 1.2 shall replace the Military Part Number.

4. QUALITY ASSURANCE PROVISIONS

4.1 General. The Quality Assurance Provision of MIL-C-24308 shall be met, except where modified herein. NASA/GSFC reserves the right to perform any of the inspections set forth in the specification where such inspections are deemed necessary to assure supplies and services conform to the prescribed requirements.

4.2 Classification of inspection. The inspections specified herein are classified as follows:

- a. Materials inspection per MIL-C-24308.
- b. Qualification inspection (see 4.3).
- c. Quality Conformance inspection (see 4.4).

4.3 Qualification inspection. Qualification inspection shall be performed in accordance with MIL-C-24308, except as modified herein.

4.3.1 Residual magnetism. Residual magnetism (see 3.4.5) shall replace the magnetic permeability test in Group I of the Qualification inspection table of MIL-C-24308. The residual magnetism test shall be performed during periodic testing.

4.3.2 Outgassing. The thermal vacuum outgassing (see 3.4.6) shall be performed in accordance with 4.5.6.

- 4.3.3 Contact engagement and separation forces. The contact engagement and separation force tests shall be conducted for all contacts (removable and non-removable) procured to this specification.
- 4.3.4 Failure analysis. A failure analysis shall be performed on each connector having failed during qualification inspection. The failure analysis shall isolate the cause(s) of failure and yield adequate conclusions and initiate a plan for corrective action to eliminate the cause(s) to prevent recurrence of failure mode(s) reported (see 4.3.5).
- 4.3.5 Failure analysis. Two copies of the failure analysis report (see 4.3.4) shall be submitted to GSFC, one copy to the address listed in 6.5 and one copy to the procuring activity. The report shall include, as a minimum, the following information:
- a. Date defect occurred.
 - b. Lot number, lot size, and serial number (where applicable).
 - c. Connector type designation.
 - d. Test and/or examination at which defect was first noted.
 - e. Failure mode.
 - f. Cause of failure.
 - g. Corrective action taken or to be taken.
 - h. Effect of failure on other connector in the inspection.
 - i. Purchase orders or contracts affected.
- 4.3.6 Retention of qualification. To retain qualification, the retention of qualification requirements in accordance with MIL-C-24308 shall be met.

4.4 Quality conformance inspection. The QCI requirements of MIL-C-24308 shall be met, except as modified herein.

4.4.1 Group A. The Group A inspection shall be performed in accordance with MIL-C-24308. In addition, each connector shall be subjected to the tests in accordance with Table I.

4.4.1.1 Sampling plan. Statistical sampling and inspection shall be in accordance with MIL-STD-105 for general inspection level II. Major and minor defects shall be as defined in MIL-STD-105. The AQL shall be 1.0 percent for major defects and 4.0 percent for minor defects.

4.4.1.2 Rejected lots. If a inspection lot is rejected, the manufacturer may rework it to correct the defect, or screen out the defective units, and resubmit for reinspection. Resubmitted lots shall be inspected using tightened inspection. Such lots shall be separate from new lots and shall be clearly identified as reinspected lots.

Table I - Acceptance Testing

Test or Examination	Requirement	Test Method	Quantity
Contact engagement and separation forces	3.4.3	4.5.3	AQL 1.0%
Residual magnetism	3.4.5	4.5.5	100%

4.4.2 Group B - Periodic Inspection. The periodic inspection shall be performed in accordance with MIL-C-24308 except as modified herein.

4.4.2.1 Residual magnetism. Residual magnetism (see 3.4.5) shall replace the magnetic permeability test in Group I of the Qualification inspection table of MIL-C-24308. The residual magnetism test shall be performed during periodic testing.

4.4.2.2 Outgassing. The thermal vacuum outgassing (see 3.4.6) shall be performed in accordance with 4.5.6.

4.5 Test methods

4.5.1 Dielectric withstanding voltage.

- 4.5.1.1 Sea level. Unmated connectors shall be tested in accordance with method 3001, condition I of MIL-STD-1344. The voltage shall be applied for a minimum of 10 seconds.
- 4.5.1.2 Altitude. The connectors shall be tested in accordance with method 3001, condition IV of MIL-STD-1344. After five (5) minutes at simulated altitude the connector shall be tested as specified in 4.5.1.1.

4.5.2 Connector mating and unmating forces. Mated connectors shall be tested in accordance with method 2013 of MIL-STD 1344. The rate of mating and unmating shall be 1 to 10 inches per minute.

4.5.3 Contact engagement and separation forces. The contact engagement and separation forces tests shall be conducted in accordance with Method 2014 of MIL-STD-1344.

4.5.4 Contact retention. Connectors shall be tested in accordance with method 2007 of MIL-STD-1344. The following shall apply:

- a. Axial direction: Shall be applied in both directions.
- b. Axial load: As specified in 3.4.4.

4.5.5 Residual magnetism.

4.5.5.1 Acceptable test method. Connector shall be fully assembled before testing. The residual magnetism test shall be performed in a magnetically quiet area, i.e. where machines, electronic equipment, vehicles, and personnel traffic are restricted. Refer to the test arrangement of Figure 1 and proceed as follows:

- a. Warm up the milliammeter for a minimum of fifteen minutes.
- b. Mount the probe in the nonmagnetic stand in a horizontal position at full cable length from the milliammeter.
- c. With the meter preset to the appropriate scale, align the probe in a magnetic E-W direction or orient to obtain a zero reading on the meter.

- d. Pass the connector specimen three times between the poles of a magnet with a field strength of approximately 5000 gauss. The connector shall not contact the pole pieces.
- e. Immediately, place the connector to within one-eighth (1/8) inch of the probe tip and orient the specimen for a maximum magnetism reading. The measurement unit shall be in gamma, where one gamma is equivalent to 1×10^{-5} gauss.

4.5.5.2 Alternative test method. An alternative residual magnetism test method may be used with approval from GSFC.

4.5.6 Outgassing. The outgassing test shall be conducted in accordance with ASTM-E595.

5. PREPARATION FOR DELIVERY

5.1 Preservation and packaging. Preservation and packaging shall be in accordance with MIL-C-55330. The manufacturer shall be responsible for any damage to or deterioration of connectors and contacts resulting from faulty or improper packing, preservation, or packaging, and shall replace connectors and/or contacts without cost to GSFC or to the procuring activity.

6. NOTES

6.1 Application guidance.

6.1.1 MIL-C-24308 covers the use of contact sizes 20 or 22D only. For connectors using multiple sized contacts in a single arrangement consult Parts Engineering.

6.1.2 Application restrictions concerning the use of these connectors are those specified in MIL-STD-1353.

6.1.3 Demagnetization. All connectors shall be demagnetized in a field strength of 1500 gauss (minimum) for a period not less than 2 seconds at peak level of demagnetization before installation.

6.2 Ordering data. Procurement documents shall specify the following:

a. Title, number and date of this specification.

b. Nomenclature by class, type, finish, style, size and part number.

6.3 Definitions. Definitions shall be those listed in MIL-STD-1353.

6.4 Qualification provisions. With respect to product requiring qualification, awards will be made only for product which have been tested and approved by GSFC before the time for opening of bids. The attention of the suppliers is called to this requirement: manufacturers should arrange to have qualification tests made on product which they intend to offer to GSFC to become eligible for awards of contracts or orders for product covered by this specification. The manufacturer shall bear the cost of qualification inspection to this specification. Information pertaining to qualification of product may be obtained from the activity whose address is listed in 6.5.

6.5 NOTICE. When GSFC drawings, specifications, or other data are sent for any purpose other than in connection with a definitely related GSFC procurement operation, the United States Government thereby incurs no responsibility nor any obligation whatsoever: the fact that GSFC might have formulated, furnished or in any way supplied said drawings, specifications, or other data is not to be regarded, by implication or otherwise, as in any manner licensing the holder or any person or corporation, or conveying any rights or permission to manufacture, use, or sell any patented invention that may in any way be related thereto.

Custodian:

Code 311
Goddard Space Flight Center
Greenbelt, Maryland 20771.

The requirements for acquiring the product described herein shall consist of this specification.

REQUIREMENTS: The connectors shall conform to the design standards (MS number) indicated in table II.

TABLE II. DESIGN STANDARDS 1/

Connector-type Designation 2/	Shell size	Shell MS number 3/	GSFC insert number	Insert MS number
311P10 -1P-B-12	1	MS18268-1	-1	MS18273-1
311P10 -1P-B-15	1	MS18268-1*	-1	MS18273-1
311P10 -6P-B-12	1	MS18268-1	-6	4/
311P10 -6P-B-15	1	MS18268-1*	-6	4/
311P10 -1S-B-12	1	MS18269-1	-1	MS18273-1
311P10 -1S-B-15	1	MS18269-1*	-1	MS18273-1
311P10 -6S-B-12	1	MS18269-1	-6	4/
311P10 -6S-B-15	1	MS18269-1*	-6	4/
311P10 -2P-B-12	2	MS18268-2	-2	MS18274-1
311P10 -2P-B-15	2	MS18268-2*	-2	MS18274-1
311P10 -7P-B-12	2	MS18268-2	-7	4/
311P10 -7P-B-15	2	MS18268-2*	-7	4/
311P10 -8P-B-12	2	MS18268-2	-8	4/
311P10 -8P-B-15	2	MS18268-2*	-8	4/
311P10 -9P-B-12	2	MS18268-2	-9	4/
311P10 -9P-B-15	2	MS18268-2*	-9	4/
311P10 -2S-B-12	2	MS18269-2	-2	MS18274-1
311P10 -2S-B-15	2	MS18269-2*	-2	MS18274-1
311P10 -7S-B-12	2	MS18269-2	-7	4/
311P10 -7S-B-15	2	MS18269-2*	-7	4/
311P10 -8S-B-12	2	MS18269-2	-8	4/
311P10 -8S-B-15	2	MS18269-2*	-8	4/
311P10 -9S-B-12	2	MS18269-2	-9	4/
311P10 -9S-B-15	2	MS18269-2*	-9	4/

See footnotes at end of table

Table II - DESIGN STANDARDS 1/ (cont'd)

Connector-type Designation 2/	Shell size	Shell MS number 3/	GSFC insert number	Insert MS number
311P10 -3P-B-12	3	MS18268-3	-3	MS18275-1
311P10 -3P-B-15	3	MS18268-3*	-3	MS18275-1
311P10 -10P-B-12	3	MS18268-3	-10	4/
311P10 -10P-B-15	3	MS18268-3*	-10	4/
311P10 -11P-B-12	3	MS18268-3	-11	4/
311P10 -11P-B-15	3	MS18268-3*	-11	4/
311P10 -12P-B-12	3	MS18268-3	-12	4/
311P10 -12P-B-15	3	MS18268-3*	-12	4/
311P10 -13P-B-12	3	MS18268-3	-13	4/
311P10 -13P-B-15	3	MS18268-3*	-13	4/
311P10 -14P-B-12	3	MS18268-3	-14	4/
311P10 -14P-B-15	3	MS18268-3*	-14	4/
311P10 -3S-B-12	3	MS18269-3	-3	MS18275-1
311P10 -3S-B-15	3	MS18269-3*	-3	MS18275-1
311P10 -10S-B-12	3	MS18269-3	-10	4/
311P10 -10S-B-15	3	MS18269-3*	-10	4/
311P10 -11S-B-12	3	MS18269-3	-11	4/
311P10 -11S-B-15	3	MS18269-3*	-11	4/
311P10 -12S-B-12	3	MS18269-3	-12	4/
311P10 -12S-B-15	3	MS18269-3*	-12	4/
311P10 -13S-B-12	3	MS18269-3	-13	4/
311P10 -13S-B-15	3	MS18269-3*	-13	4/
311P10 -14S-B-12	3	MS18269-3	-14	4/
311P10 -14S-B-15	3	MS18269-3*	-14	4/
311P10 -4P-B-12	4	MS18268-4	-4	MS18276-1
311P10 -4P-B-15	4	MS18268-4*	-4	MS18276-1
311P10 -15P-B-12	4	MS18268-4	-15	4/
311P10 -15P-B-15	4	MS18268-4*	-15	4/
311P10 -16P-B-12	4	MS18268-4	-16	4/
311P10 -16P-B-15	4	MS18268-4*	-16	4/
311P10 -17P-B-12	4	MS18268-4	-17	4/
311P10 -17P-B-15	4	MS18268-4*	-17	4/
311P10 -18P-B-12	4	MS18268-4	-18	4/
311P10 -18P-B-15	4	MS18268-4*	-18	4/
311P10 -19P-B-12		-----CANCELLED-----		5/
311P10 -19P-B-15		-----CANCELLED-----		5/
311P10 -20P-B-12	4	MS18268-4	-20	4/
311P10 -20P-B-15	4	MS18268-4*	-20	4/
311P10 -21P-B-12	4	MS18268-4	-21	4/
311P10 -21P-B-15	4	MS18268-4*	-21	4/

See footnotes at end of table

Table II - DESIGN STANDARDS 1/ (cont'd)

Connector-type Designation 2/	Shell size	Shell MS number 3/	GSFC insert number	Insert MS number
311P10 -4S-B-12	4	MS18269-4	-4	MS18276-1
311P10 -4S-B-15	4	MS18269-4*	-4	MS18276-1
311P10 -15S-B-12	4	MS18269-4	-15	4/
311P10 -15S-B-15	4	MS18269-4*	-15	4/
311P10 -16S-B-12	4	MS18269-4	-16	4/
311P10 -16S-B-15	4	MS18269-4*	-16	4/
311P10 -17S-B-12	4	MS18269-4	-17	4/
311P10 -17S-B-15	4	MS18269-4*	-17	4/
311P10 -18S-B-12	4	MS18269-4	-18	4/
311P10 -18S-B-15	4	MS18269-4*	-18	4/
311P10 -19S-B-12		-----CANCELLED-----		5/
311P10 -19S-B-15		-----CANCELLED-----		5/
311P10 -20S-B-12	4	MS18269-4	-20	4/
311P10 -20S-B-15	4	MS18269-4*	-20	4/
311P10 -21S-B-12	4	MS18269-4	-21	4/
311P10 -21S-B-15	4	MS18269-4*	-21	4/
311P10 -5P-B-12	5	MS18268-5	-5	MS18277-1
311P10 -5P-B-15	5	MS18268-5*	-5	MS18277-1
311P10 -22P-B-12	5	MS18268-5	-22	4/
311P10 -22P-B-15	5	MS18268-5*	-22	4/
311P10 -23P-B-12	5	MS18268-5	-23	4/
311P10 -24P-B-12	5	MS18268-5	-24	4/
311P10 -25P-B-12	5	MS18268-5	-25	4/
311P10 -25P-B-15	5	MS18268-5*	-25	4/
311P10 -5S-B-12	5	MS18269-5	-5	MS18277-1
311P10 -5S-B-15	5	MS18269-5*	-5	MS18277-1
311P10 -22S-B-12	5	MS18269-5	-22	4/
311P10 -22S-B-15	5	MS18269-5*	-22	4/
311P10 -23S-B-12	5	MS18269-5	-23	4/
311P10 -23S-B-15	5	MS18269-5*	-23	4/
311P10 -24S-B-12	5	MS18269-5	-24	4/
311P10 -24S-B-15	5	MS18269-5*	-24	4/
311P10 -25S-B-12	5	MS18269-5	-25	4/
311P10 -25S-B-15	5	MS18269-5*	-25	4/

See footnotes at end of table

TABLE II. DESIGN STANDARDS 1/

Connector-type Designation 2/	Shell size	Shell MS number 3/	GSFC insert number	Insert MS number
311P10 -1P-C-12	1	MS18268-1	-1	MS18273-1
311P10 -1P-C-15	1	MS18268-1*	-1	MS18273-1
311P10 -6P-C-12	1	MS18268-1	-6	4/
311P10 -6P-C-15	1	MS18268-1*	-6	4/
311P10 -1S-C-12	1	MS18269-1	-1	MS18273-1
311P10 -1S-C-15	1	MS18269-1*	-1	MS18273-1
311P10 -6S-C-12	1	MS18269-1	-6	4/
311P10 -6S-C-15	1	MS18269-1*	-6	4/
311P10 -2P-C-12	2	MS18268-2	-2	MS18274-1
311P10 -2P-C-15	2	MS18268-2*	-2	MS18274-1
311P10 -7P-C-12	2	MS18268-2	-7	4/
311P10 -7P-C-15	2	MS18268-2*	-7	4/
311P10 -8P-C-12	2	MS18268-2	-8	4/
311P10 -8P-C-15	2	MS18268-2*	-8	4/
311P10 -9P-C-12	2	MS18268-2	-9	4/
311P10 -9P-C-15	2	MS18268-2*	-9	4/
311P10 -2S-C-12	2	MS18269-2	-2	MS18274-1
311P10 -2S-C-15	2	MS18269-2*	-2	MS18274-1
311P10 -7S-C-12	2	MS18269-2	-7	4/
311P10 -7S-C-15	2	MS18269-2*	-7	4/
311P10 -8S-C-12	2	MS18269-2	-8	4/
311P10 -8S-C-15	2	MS18269-2*	-8	4/
311P10 -9S-C-12	2	MS18269-2	-9	4/
311P10 -9S-C-15	2	MS18269-2*	-9	4/

See footnotes at end of table

Table II - DESIGN STANDARDS 1/ (cont'd)

Connector-type Designation 2/	Shell size	Shell MS number 3/	GSFC insert number	Insert MS number
311P10 -4S-C-12	4	MS18269-4	-4	MS18276-1
311P10 -4S-C-15	4	MS18269-4*	-4	MS18276-1
311P10 -15S-C-12	4	MS18269-4	-15	<u>4/</u>
311P10 -15S-C-15	4	MS18269-4*	-15	<u>4/</u>
311P10 -16S-C-12	4	MS18269-4	-16	<u>4/</u>
311P10 -16S-C-15	4	MS18269-4*	-16	<u>4/</u>
311P10 -17S-C-12	4	MS18269-4	-17	<u>4/</u>
311P10 -17S-C-15	4	MS18269-4*	-17	<u>4/</u>
311P10 -18S-C-12	4	MS18269-4	-18	<u>4/</u>
311P10 -18S-C-15	4	MS18269-4*	-18	<u>4/</u>
311P10 -19S-C-12	-----CANCELLED-----			<u>5/</u>
311P10 -19S-C-15	-----CANCELLED-----			<u>5/</u>
311P10 -20S-C-12	4	MS18269-4	-20	<u>4/</u>
311P10 -20S-C-15	4	MS18269-4*	-20	<u>4/</u>
311P10 -21S-C-12	4	MS18269-4	-21	<u>4/</u>
311P10 -21S-C-15	4	MS18269-4*	-21	<u>4/</u>
311P10 -5P-C-12	5	MS18268-5	-5	MS18277-1
311P10 -5P-C-15	5	MS18268-5*	-5	MS18277-1
311P10 -22P-C-12	5	MS18268-5	-22	<u>4/</u>
311P10 -22P-C-15	5	MS18268-5*	-22	<u>4/</u>
311P10 -23P-C-12	5	MS18268-5	-23	<u>4/</u>
311P10 -24P-C-12	5	MS18268-5	-24	<u>4/</u>
311P10 -25P-C-12	5	MS18268-5	-25	<u>4/</u>
311P10 -25P-C-15	5	MS18268-5*	-25	<u>4/</u>
311P10 -5S-C-12	5	MS18269-5	-5	MS18277-1
311P10 -5S-C-15	5	MS18269-5*	-5	MS18277-1
311P10 -22S-C-12	5	MS18269-5	-22	<u>4/</u>
311P10 -22S-C-15	5	MS18269-5*	-22	<u>4/</u>
311P10 -23S-C-12	5	MS18269-5	-23	<u>4/</u>
311P10 -23S-C-15	5	MS18269-5*	-23	<u>4/</u>
311P10 -24S-C-12	5	MS18269-5	-24	<u>4/</u>
311P10 -24S-C-15	5	MS18269-5*	-24	<u>4/</u>
311P10 -25S-C-12	5	MS18269-5	-25	<u>4/</u>
311P10 -25S-C-15	5	MS18269-5*	-25	<u>4/</u>

See footnotes at end of table

Table II - DESIGN STANDARDS 1/ (cont'd)

Connector-type Designation 2/	Shell size	Shell MS number 3/	GSFC insert number	Insert MS number
311P10 -3P-C-12	3	MS18268-3	-3	MS18275-1
311P10 -3P-C-15	3	MS18268-3*	-3	MS18275-1
311P10 -10P-C-12	3	MS18268-3	-10	4/
311P10 -10P-C-15	3	MS18268-3*	-10	4/
311P10 -11P-C-12	3	MS18268-3	-11	4/
311P10 -11P-C-15	3	MS18268-3*	-11	4/
311P10 -12P-C-12	3	MS18268-3	-12	4/
311P10 -12P-C-15	3	MS18268-3*	-12	4/
311P10 -13P-C-12	3	MS18268-3	-13	4/
311P10 -13P-C-15	3	MS18268-3*	-13	4/
311P10 -14P-C-12	3	MS18268-3	-14	4/
311P10 -14P-C-15	3	MS18268-3*	-14	4/
311P10 -3S-C-12	3	MS18269-3	-3	MS18275-1
311P10 -3S-C-15	3	MS18269-3*	-3	MS18275-1
311P10 -10S-C-12	3	MS18269-3	-10	4/
311P10 -10S-C-15	3	MS18269-3*	-10	4/
311P10 -11S-C-12	3	MS18269-3	-11	4/
311P10 -11S-C-15	3	MS18269-3*	-11	4/
311P10 -12S-C-12	3	MS18269-3	-12	4/
311P10 -12S-C-15	3	MS18269-3*	-12	4/
311P10 -13S-C-12	3	MS18269-3	-13	4/
311P10 -13S-C-15	3	MS18269-3*	-13	4/
311P10 -14S-C-12	3	MS18269-3	-14	4/
311P10 -14S-C-15	3	MS18269-3*	-14	4/
311P10 -4P-C-12	4	MS18268-4	-4	MS18276-1
311P10 -4P-C-15	4	MS18268-4*	-4	MS18276-1
311P10 -15P-C-12	4	MS18268-4	-15	4/
311P10 -15P-C-15	4	MS18268-4*	-15	4/
311P10 -16P-C-12	4	MS18268-4	-16	4/
311P10 -16P-C-15	4	MS18268-4*	-16	4/
311P10 -17P-C-12	4	MS18268-4	-17	4/
311P10 -17P-C-15	4	MS18268-4*	-17	4/
311P10 -18P-C-12	4	MS18268-4	-18	4/
311P10 -18P-C-15	4	MS18268-4*	-18	4/
311P10 -19P-C-12		-----CANCELLED-----		5/
311P10 -19P-C-15		-----CANCELLED-----		5/
311P10 -20P-C-12	4	MS18268-4	-20	4/
311P10 -20P-C-15	4	MS18268-4*	-20	4/
311P10 -21P-C-12	4	MS18268-4	-21	4/
311P10 -21P-C-15	4	MS18268-4*	-21	4/

See footnotes at end of table

FOOTNOTES:

- 1/ These connector designated as P (for Pins) shall mate with the corresponding connector designated as S (for Sockets).
- 2/ Connectors-type designation are in accordance with 1.2.
- 3/ MS numbers identified with an asterick (*) shall have shell design and dimension in accordance with the MS number listed except that the mounting holes shall be $0.154 \pm .005$ in diameter.
- 4/ Inserts are in accordance with Figures 2-21.
- 5/ Insert arrangement 19 is no longer available for procurement.

EQUIPMENT

- 1 — Hewlett-Packard model 428B milliammeter
- 1 — Hewlett-Packard model 3529A magnetometer probe
- 1 — Nonmagnetic stand and probe holder

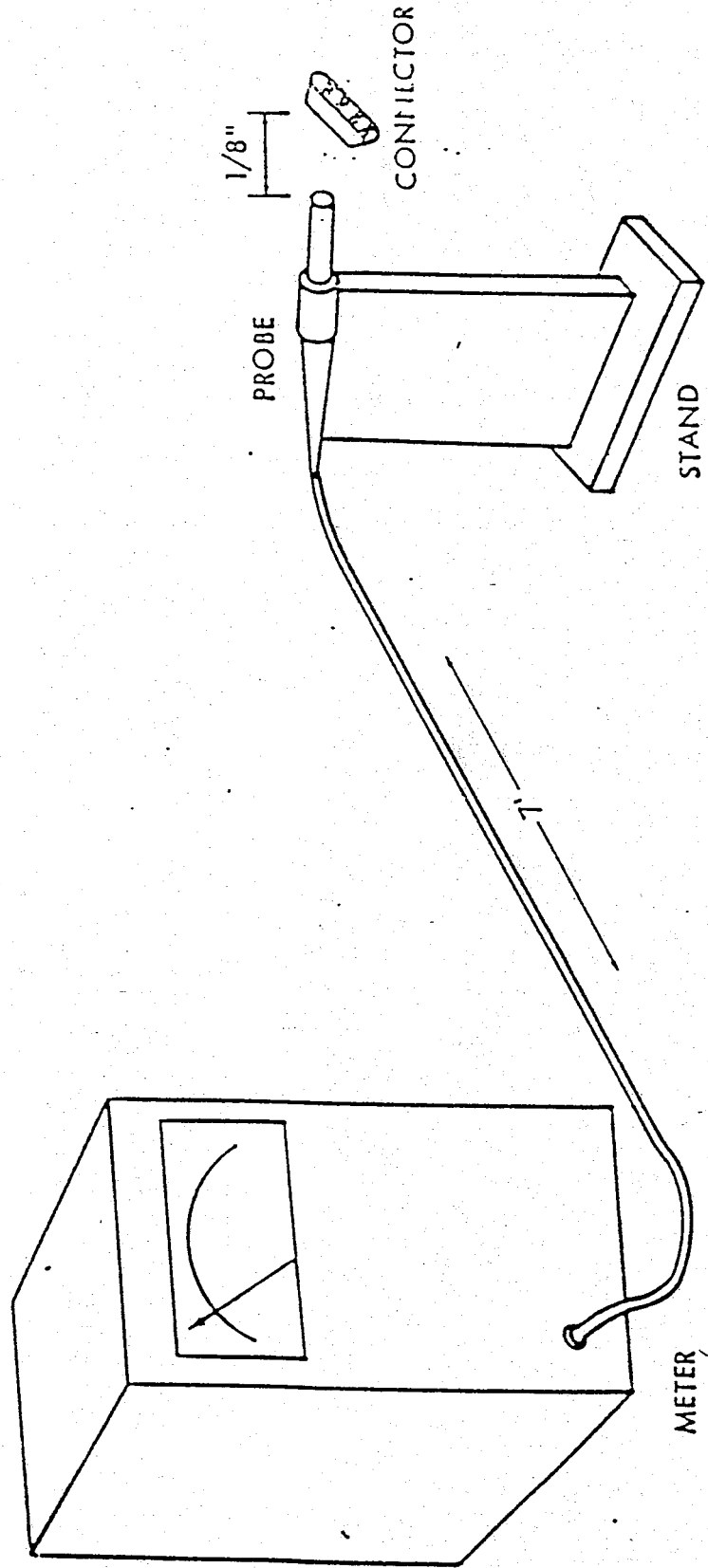
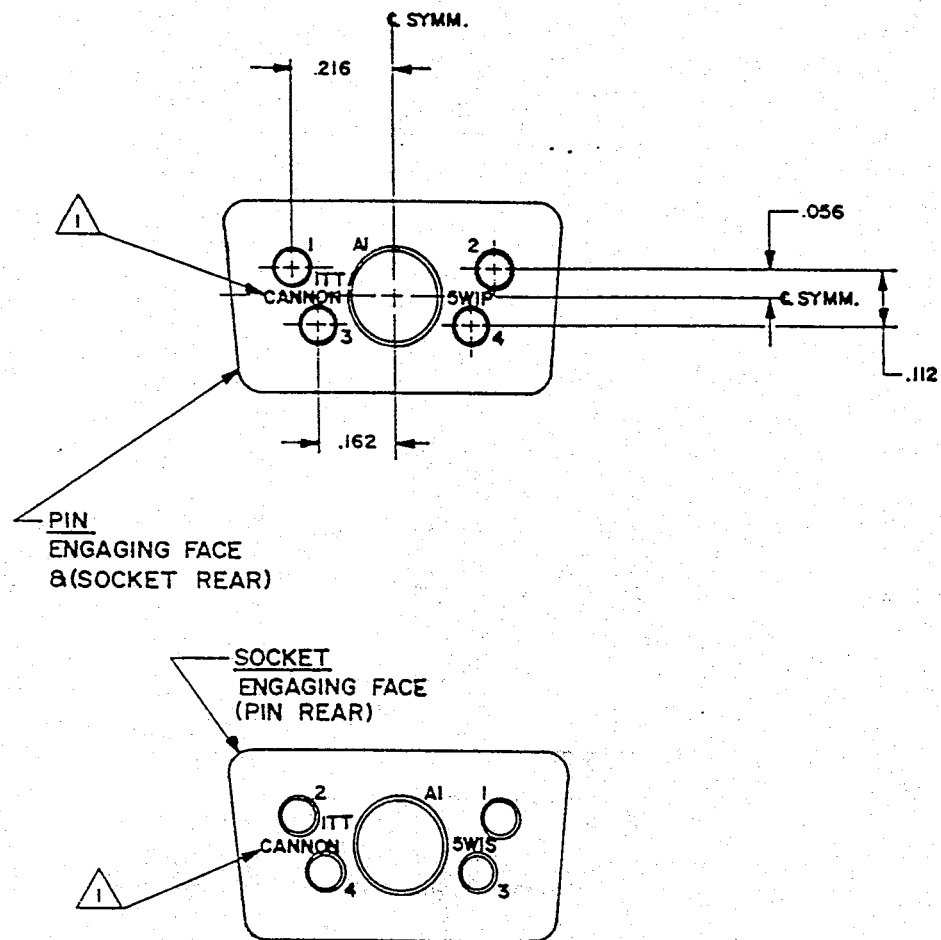
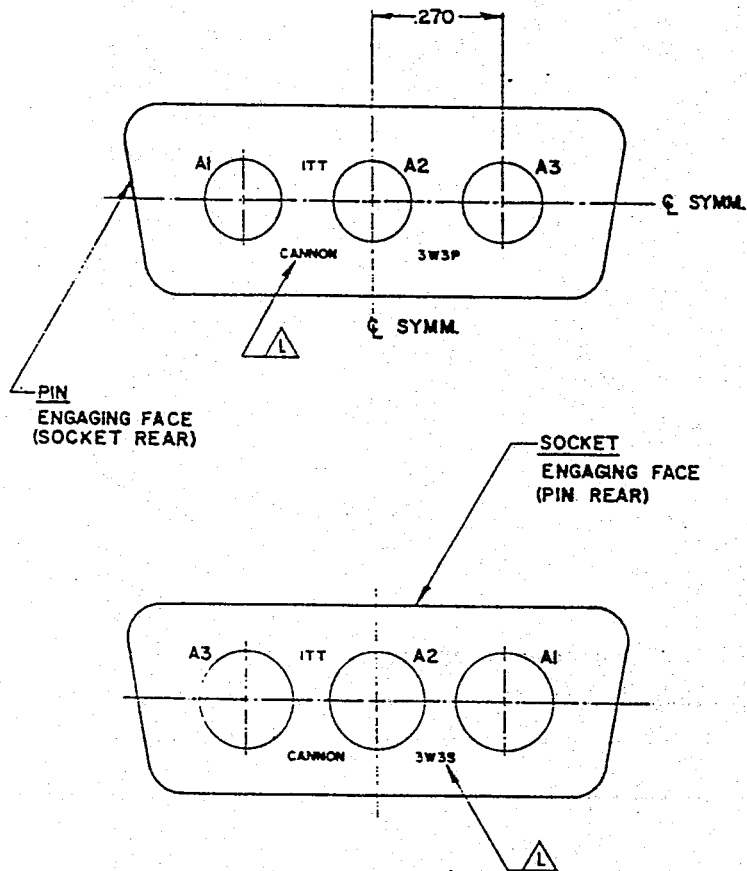

Figure 1 - Residual-Magnetism Test Arrangement



1. Manufacturer's name and manufacturer's insert part number (optional front and back of insert).
2. Contact hole locations are basic and T.P. within a .005 diameter at MMC (D+MA pin front and rear insulator holes must match within .003).
3. Insert arrangement in accordance with MS18273, except as shown.

FIGURE 2 - INSERT ARRANGEMENT 6



1.  Manufacturer's name and manufacturer's insert part number (optional front and back of insert).
2. Contact hole locations are basic and T.P. within a .005 diameter at MMC (D+MA pin front and rear insulator holes must match within .003).
3. Insert arrangement in accordance with MS18274, except as shown.

FIGURE 3 - INSERT ARRANGEMENT 7



1. Manufacturer's name and manufacturer's insert part number (optional front and back of insert).
2. Contact hole locations are basic and T.P. within a .005 diameter at MMC (D+MA pin front and rear insulator holes must match within .003).
3. Insert arrangement in accordance with MS18274, except as shown.

FIGURE 4 - INSERT ARRANGEMENT 8

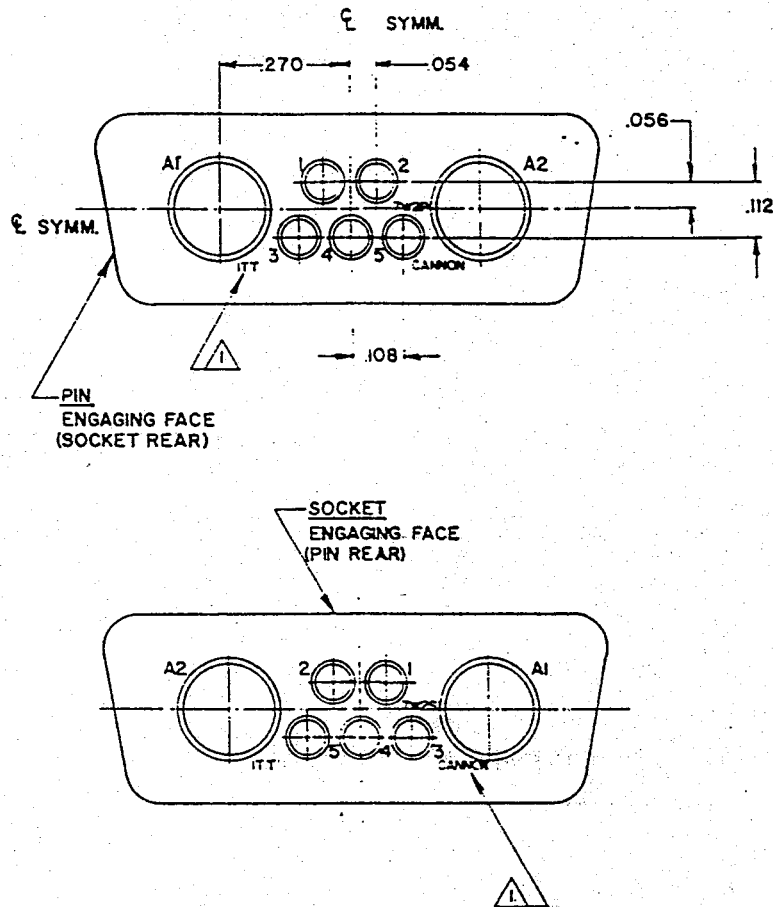
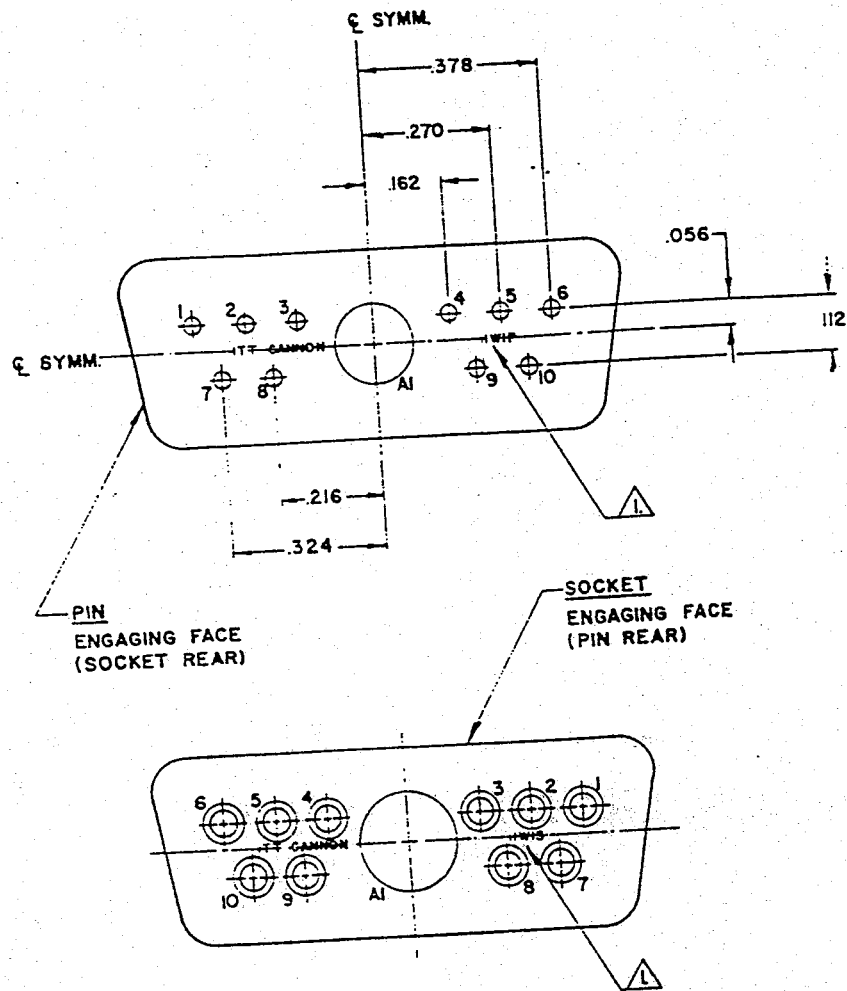

1 Manufacturer's name and manufacturer's insert part number (optional front and back of insert).

2. Contact hole locations are basic and T.P. within a .005 diameter at MMC (D+MA pin front and rear insulator holes must match within .003).

3. Insert arrangement in accordance with MS18274, except as shown.

FIGURE 5 - INSERT ARRANGEMENT 9

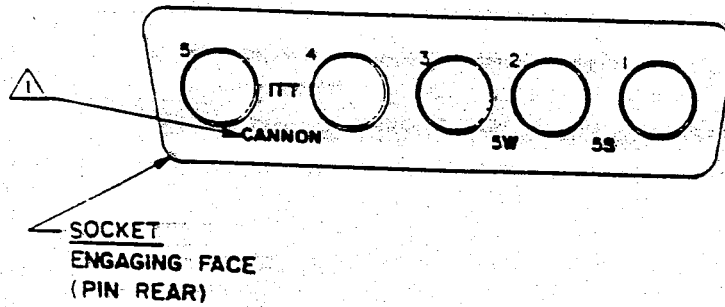
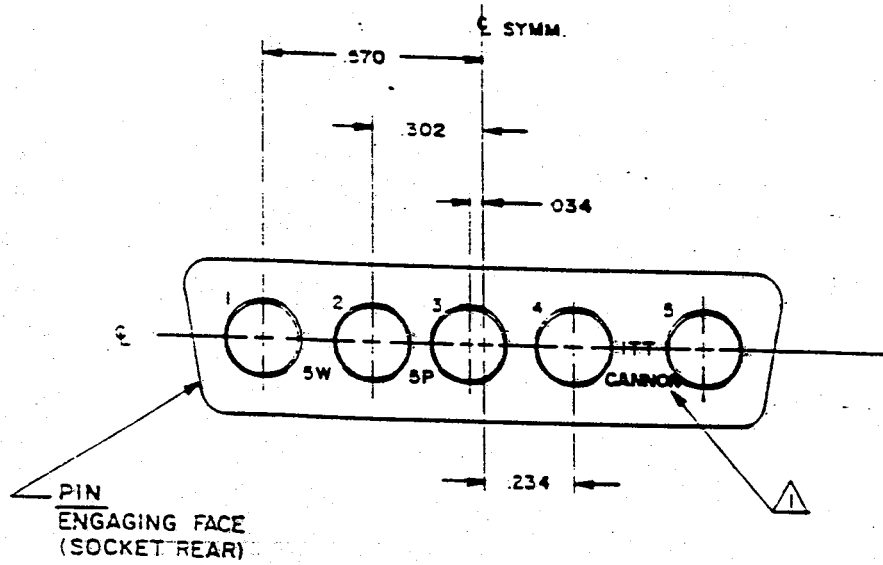

1. Manufacturer's name and manufacturer's insert part number (optional front and back of insert).
2. Contact hole locations are basic and T.P. within a .005 diameter at MMC (D+MA pin front and rear insulator holes must match within .003).
3. Insert arrangement in accordance with MS18275, except as shown.

FIGURE 6 - INSERT ARRANGEMENT 10

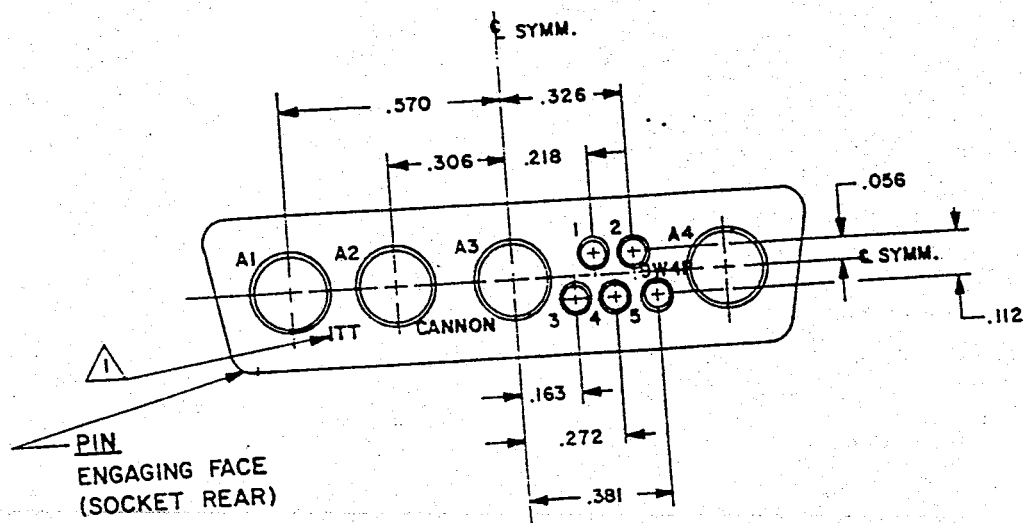

PIN
ENGAGING FACE
(SOCKET REAR)

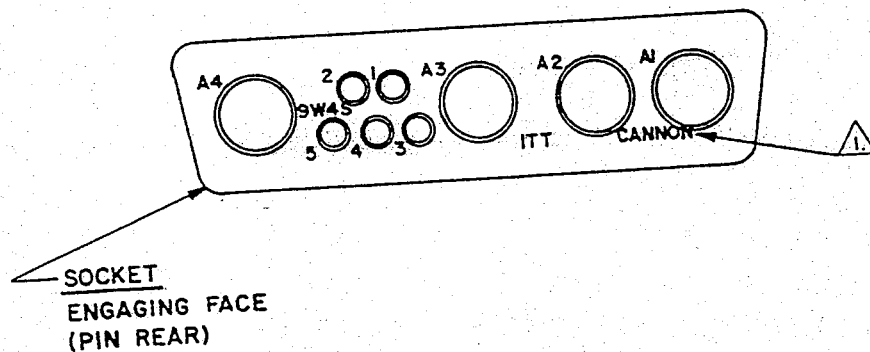

SOCKET
ENGAGING FACE
(PIN REAR)

1. Manufacturer's name and manufacturer's insert part number (optional front and back of insert).

2. Contact hole locations are basic and T.P. within a .005 diameter at MMC (D+MA pin front and rear insulator holes must match within .003).

3. Insert arrangement in accordance with MS18275, except as shown.

FIGURE 7 - INSERT ARRANGEMENT 11

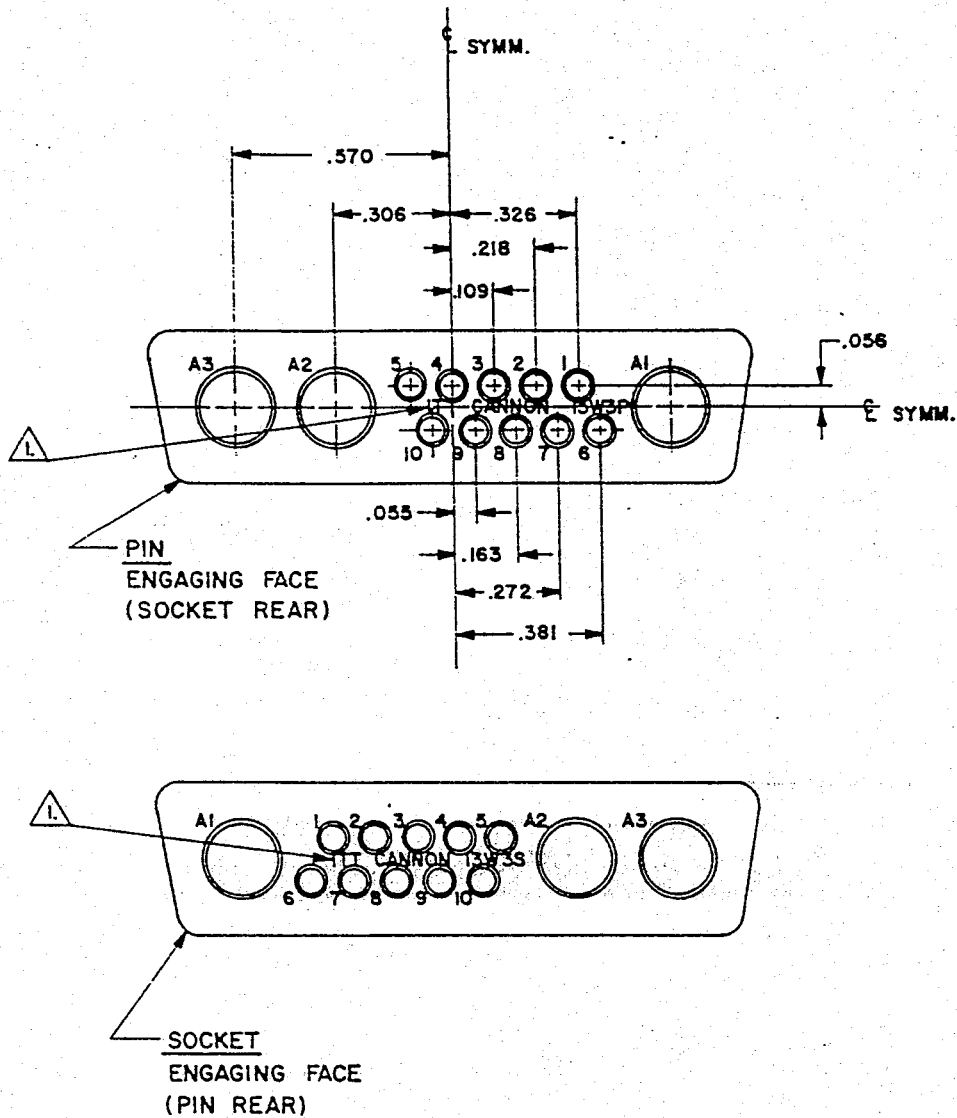

1. Manufacturer's name and manufacturer's insert part number (optional front and back of insert).
2. Contact hole locations are basic and T.P. within a .005 diameter at MMC (D+MA pin front and rear insulator holes must match within .003).
3. Insert arrangement in accordance with MS18275, except as shown.

FIGURE 8 - INSERT ARRANGEMENT 12

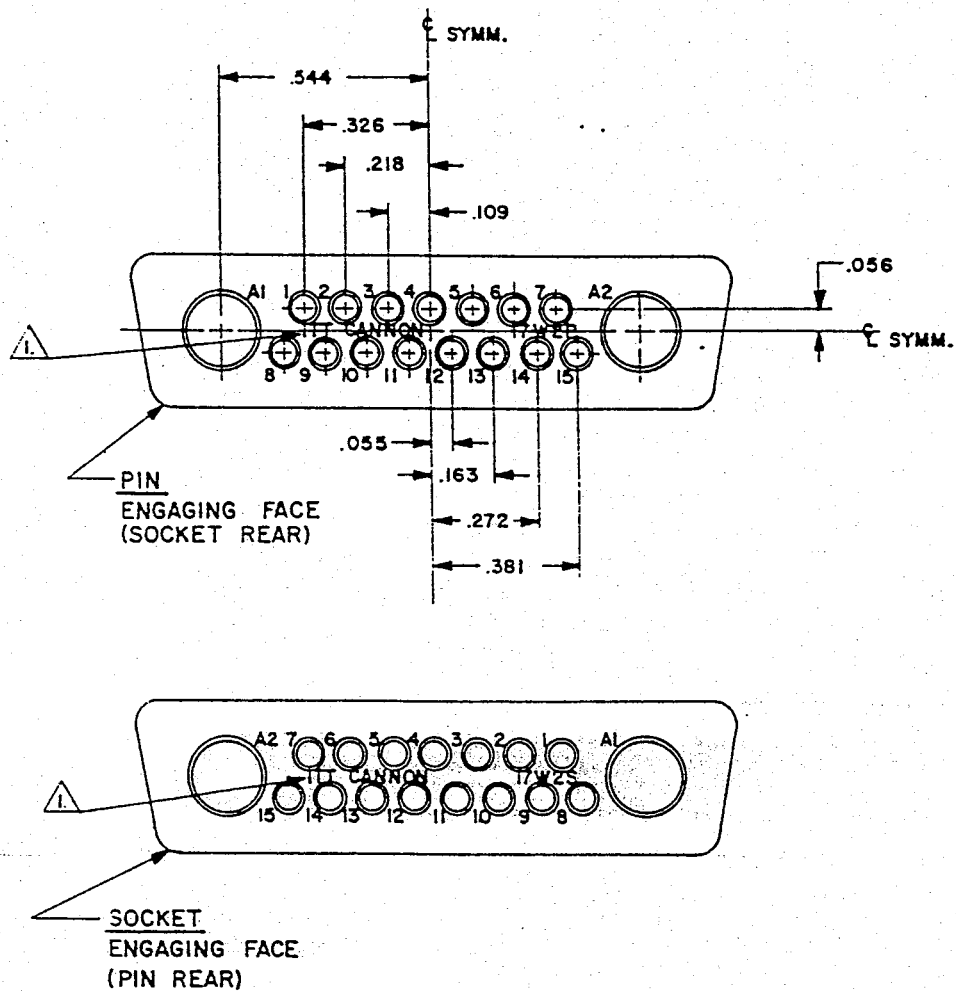

1. Manufacturer's name and manufacturer's insert part number (optional front and back of insert).
2. Contact hole locations are basic and T.P. within a .005 diameter at MMC (D+MA pin front and rear insulator holes must match within .003).
3. Insert arrangement in accordance with MS18275, except as shown.

FIGURE 9 - INSERT ARRANGEMENT 13

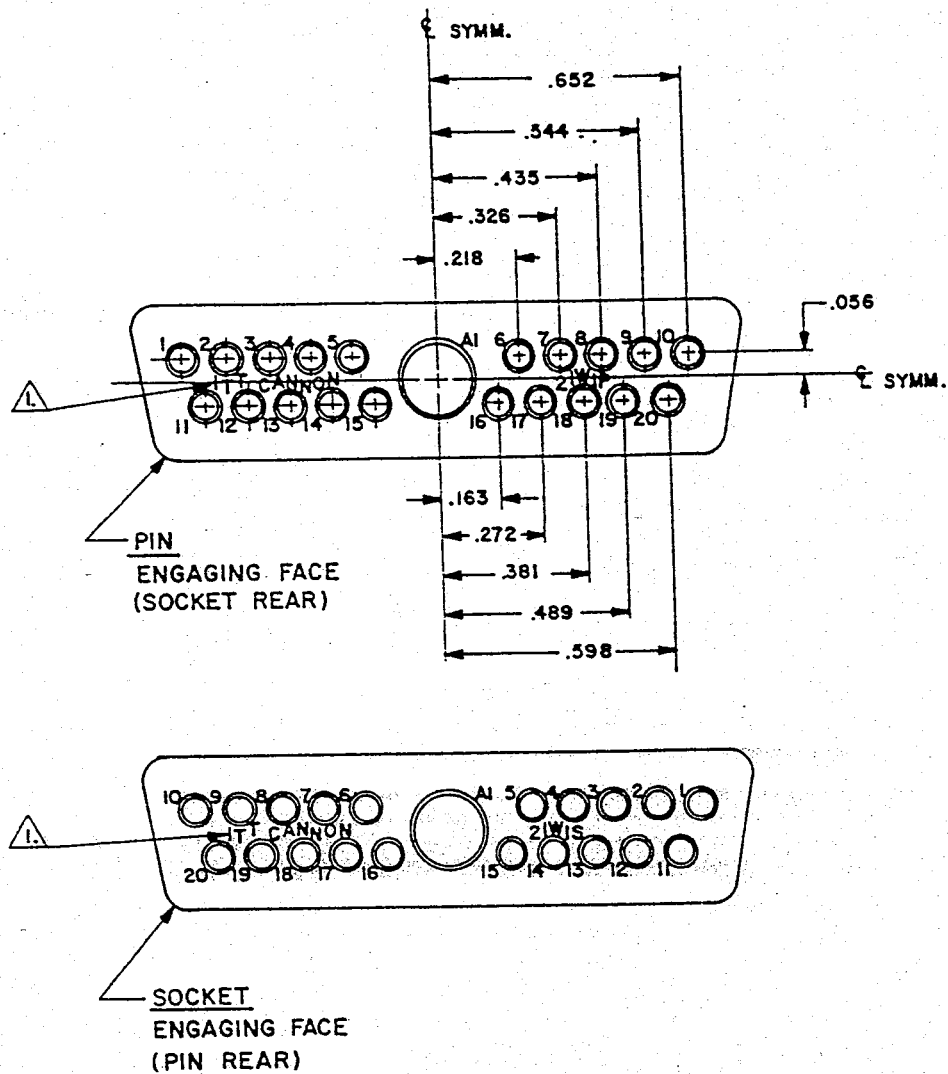

1. Manufacturer's name and manufacturer's insert part number (optional front and back of insert).

2. Contact hole locations are basic and T.P. within a .005 diameter at MMC (D+MA pin front and rear insulator holes must match within .003).

3. Insert arrangement in accordance with MS18275, except as shown.

FIGURE 10 - INSERT ARRANGEMENT 14

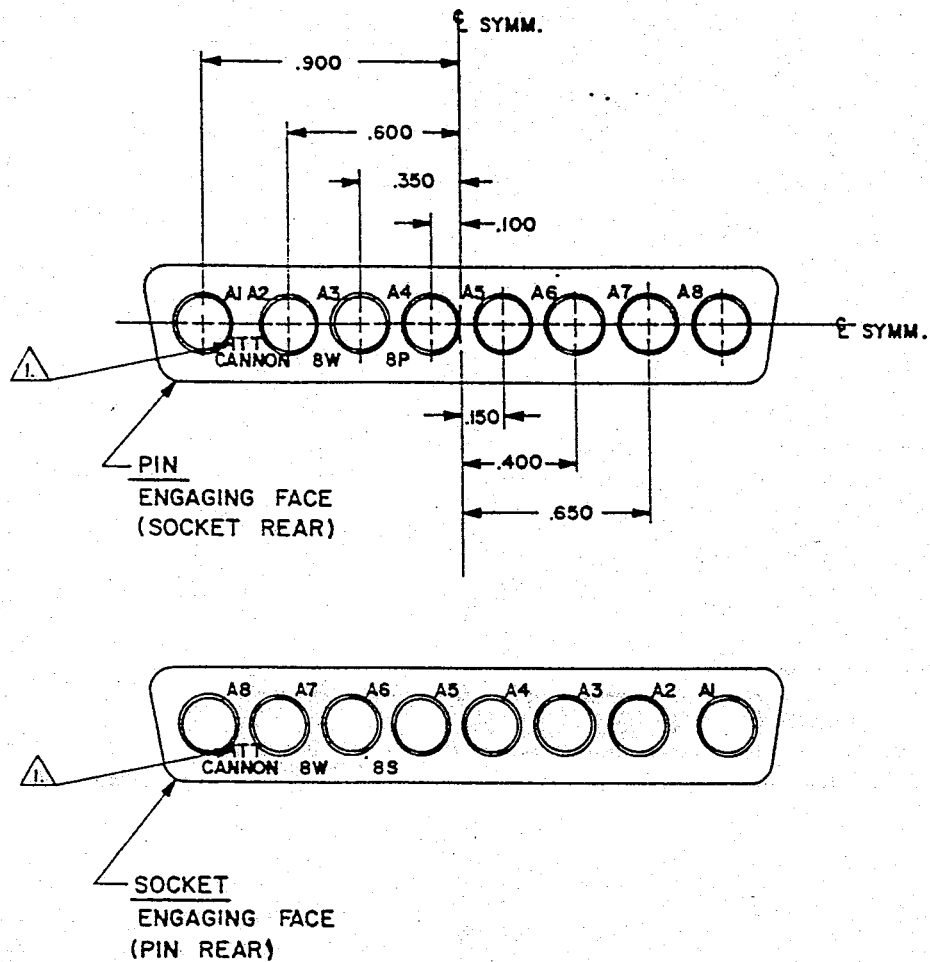

1. Manufacturer's name and manufacturer's insert part number (optional front and back of insert).
2. Contact hole locations are basic and T.P. within a .005 diameter at MMC (D+MA pin front and rear insulator holes must match within .003).
3. Insert arrangement in accordance with MS18276, except as shown.

FIGURE 11 - INSERT ARRANGEMENT 15

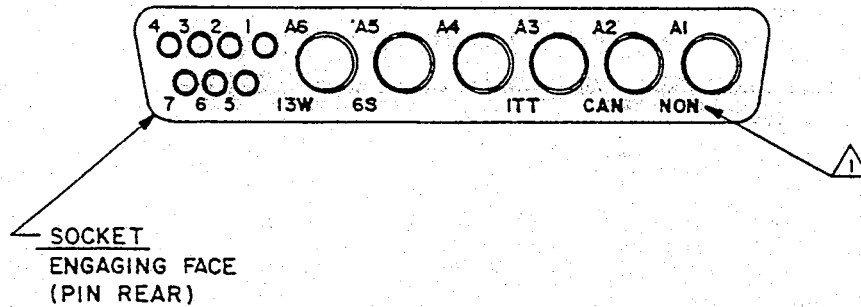
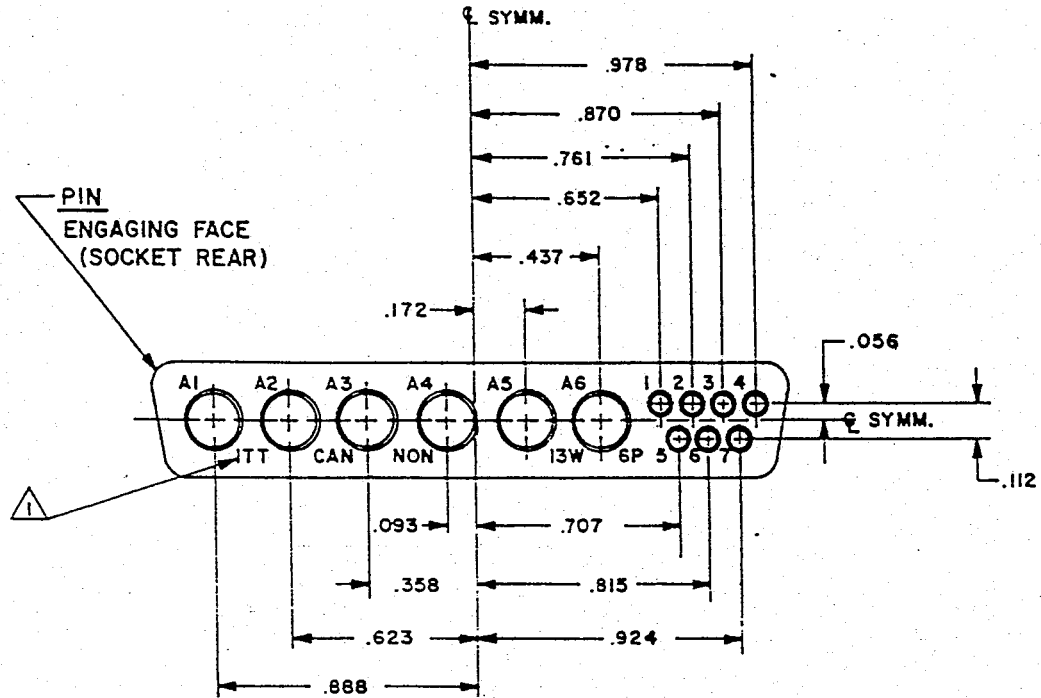

1. Manufacturer's name and manufacturer's insert part number (optional front and back of insert).

2. Contact hole locations are basic and T.P. within a .005 diameter at MMC (D+MA pin front and rear insulator holes must match within .003).

3. Insert arrangement in accordance with MS18276, except as shown.

FIGURE 12 - INSERT ARRANGEMENT 16

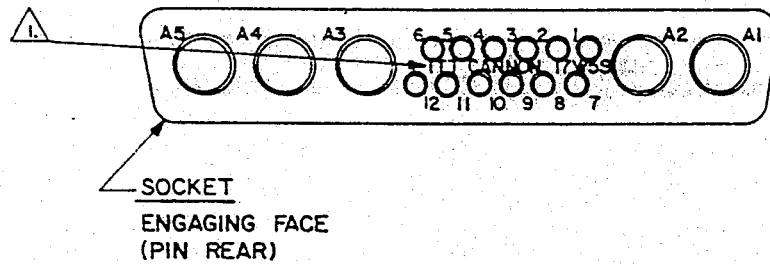
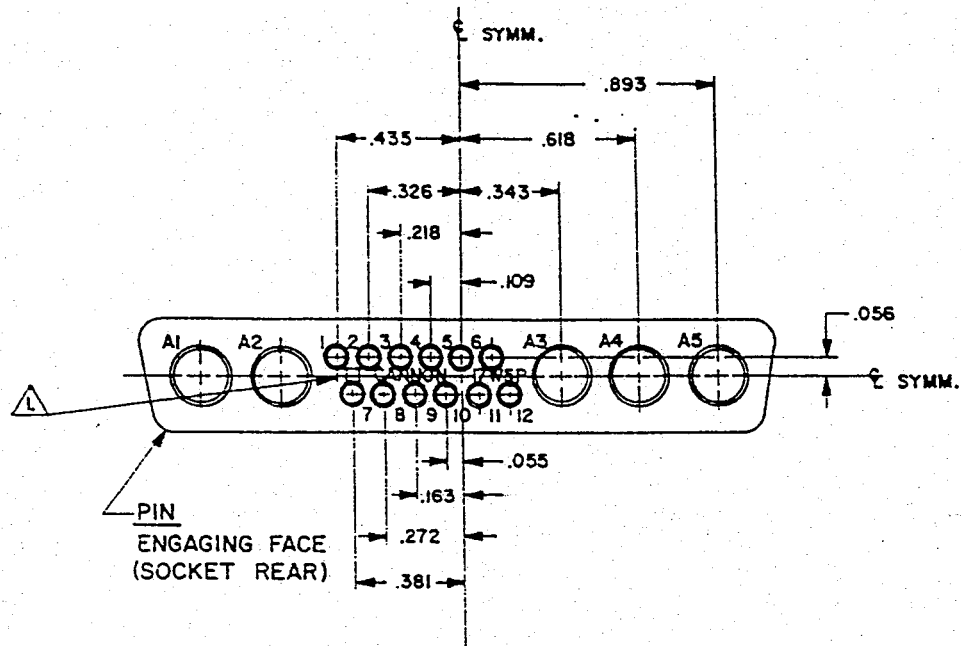

1. Manufacturer's name and manufacturer's insert part number (optional front and back of insert).
2. Contact hole locations are basic and T.P. within a .005 diameter at MMC (D+MA pin front and rear insulator holes must match within .003).
3. Insert arrangement in accordance with MS18276, except as shown.

FIGURE 13 - INSERT ARRANGEMENT 17

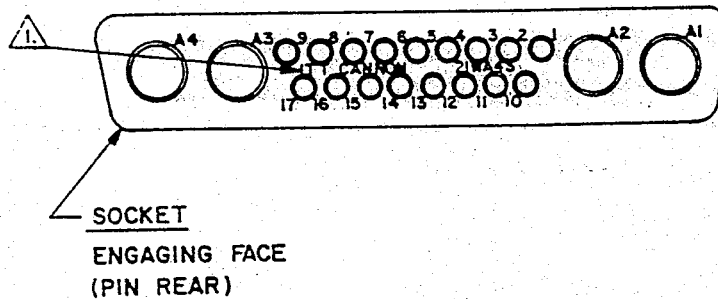
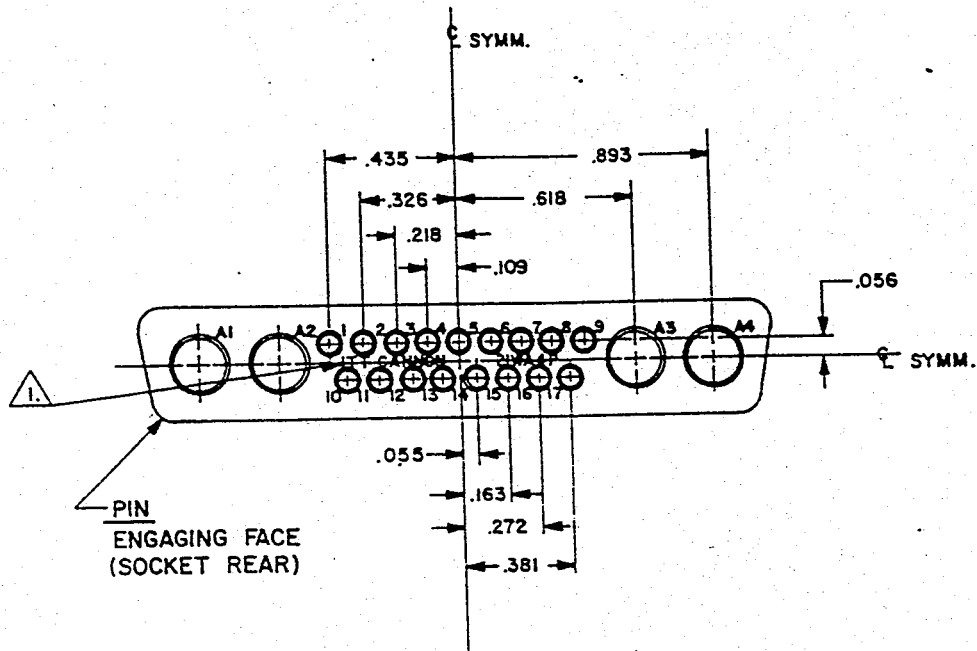

1. Manufacturer's name and manufacturer's insert part number (optional front and back of insert).

2. Contact hole locations are basic and T.P. within a .005 diameter at MMC (D+MA pin front and rear insulator holes must match within .003).

3. Insert arrangement in accordance with MS18276, except as shown.

FIGURE 14 - INSERT ARRANGEMENT 18

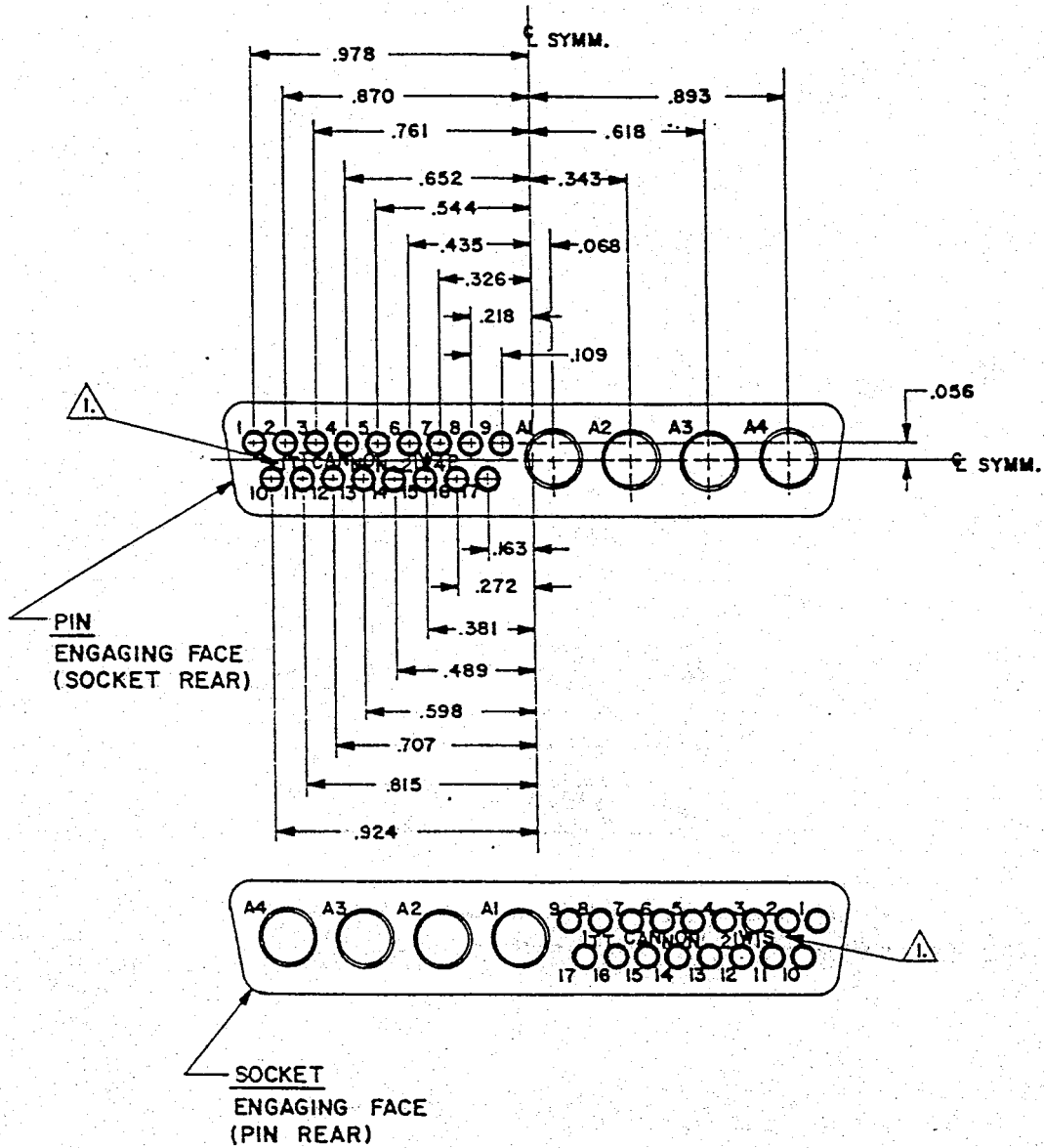

THIS INSERT ARRANGEMENT IS NOT LONGER AVAILABLE FOR PROCUREMENT.

FIGURE 15 - INSERT ARRANGEMENT 19

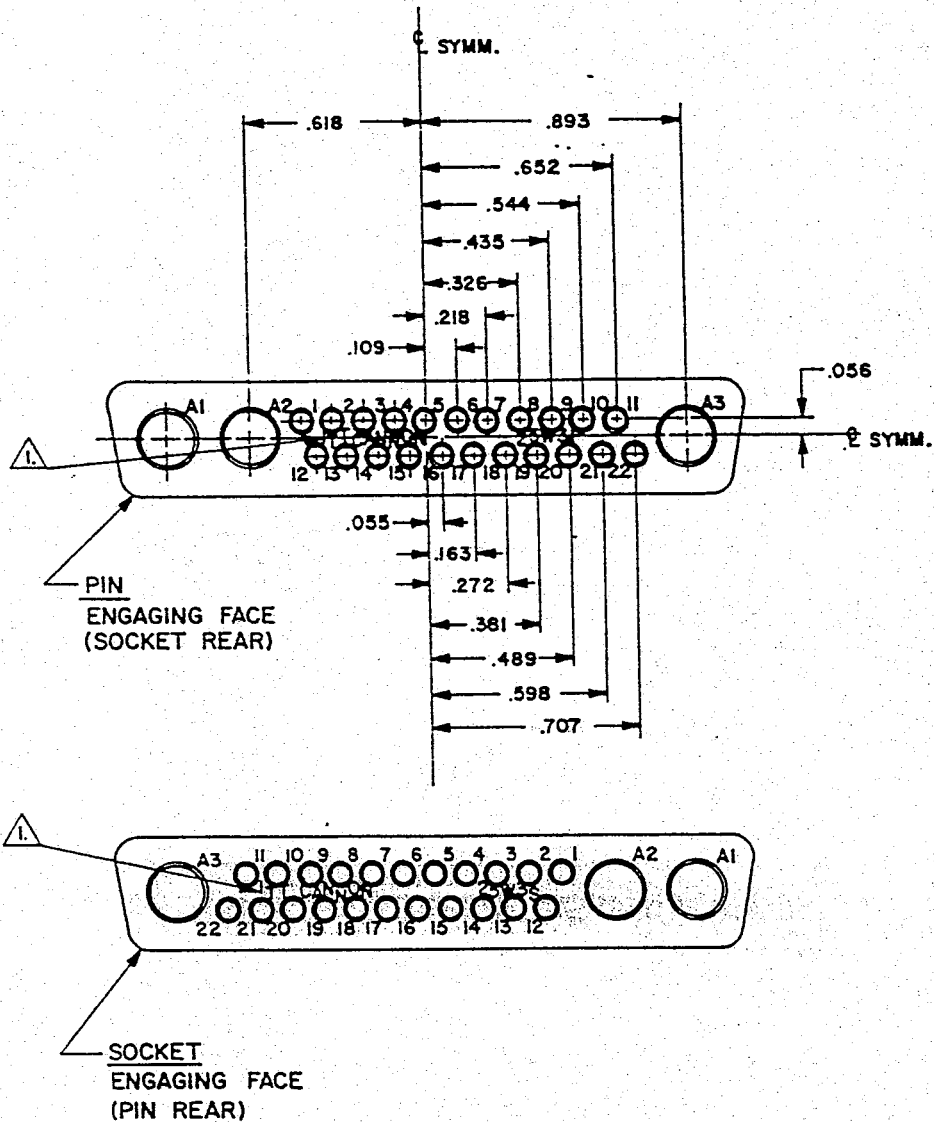

1. Manufacturer's name and manufacturer's insert part number (optional front and back of insert).
2. Contact hole locations are basic and T.P. within a .005 diameter at MMC (D+MA pin front and rear insulator holes must match within .003).
3. Insert arrangement in accordance with MS18276, except as shown.

FIGURE 16 - INSERT ARRANGEMENT 20

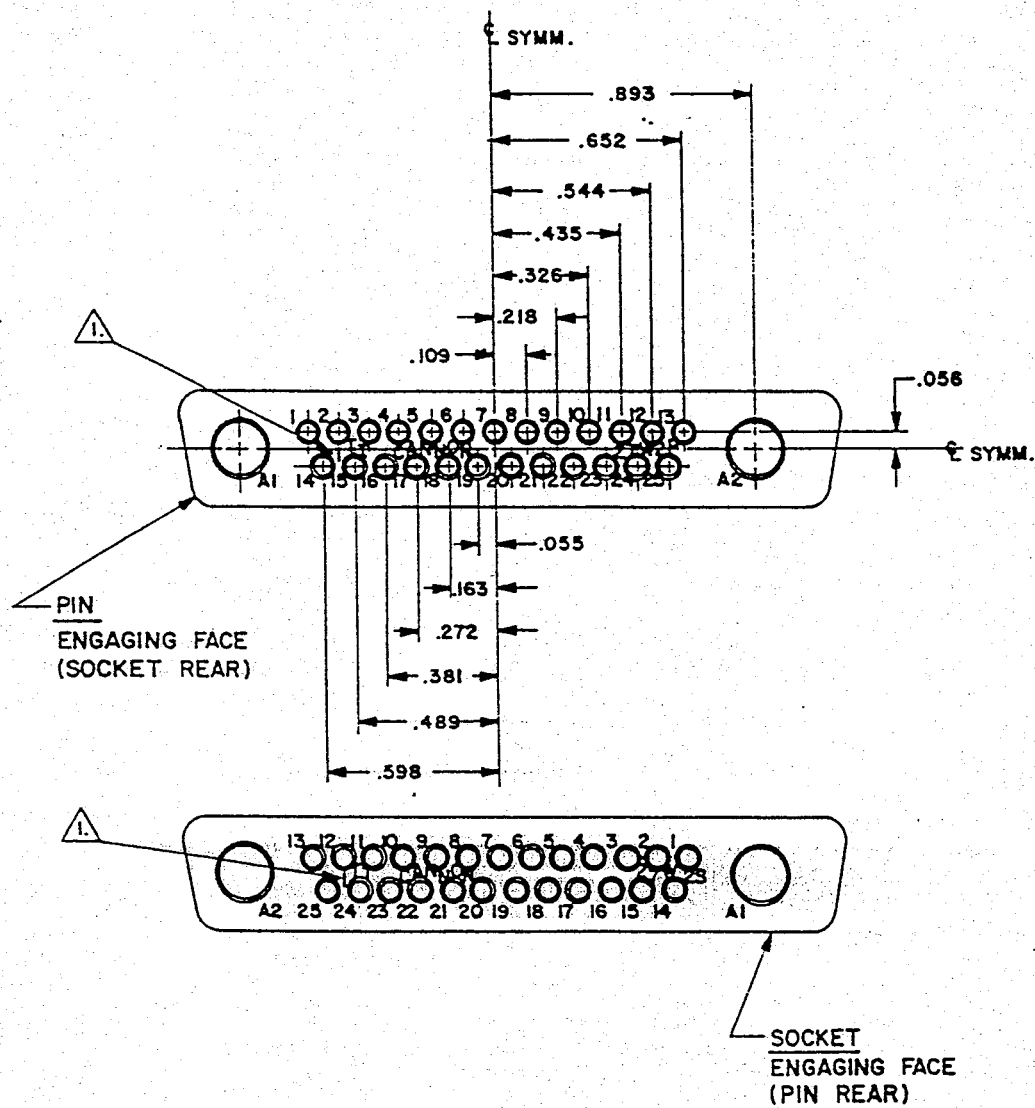

1. Manufacturer's name and manufacturer's insert part number (optional front and back of insert).

2. Contact hole locations are basic and T.P. within a .005 diameter at MMC (D+MA pin front and rear insulator holes must match within .003).

3. Insert arrangement in accordance with MS18276, except as shown.

FIGURE 17 - INSERT ARRANGEMENT 21

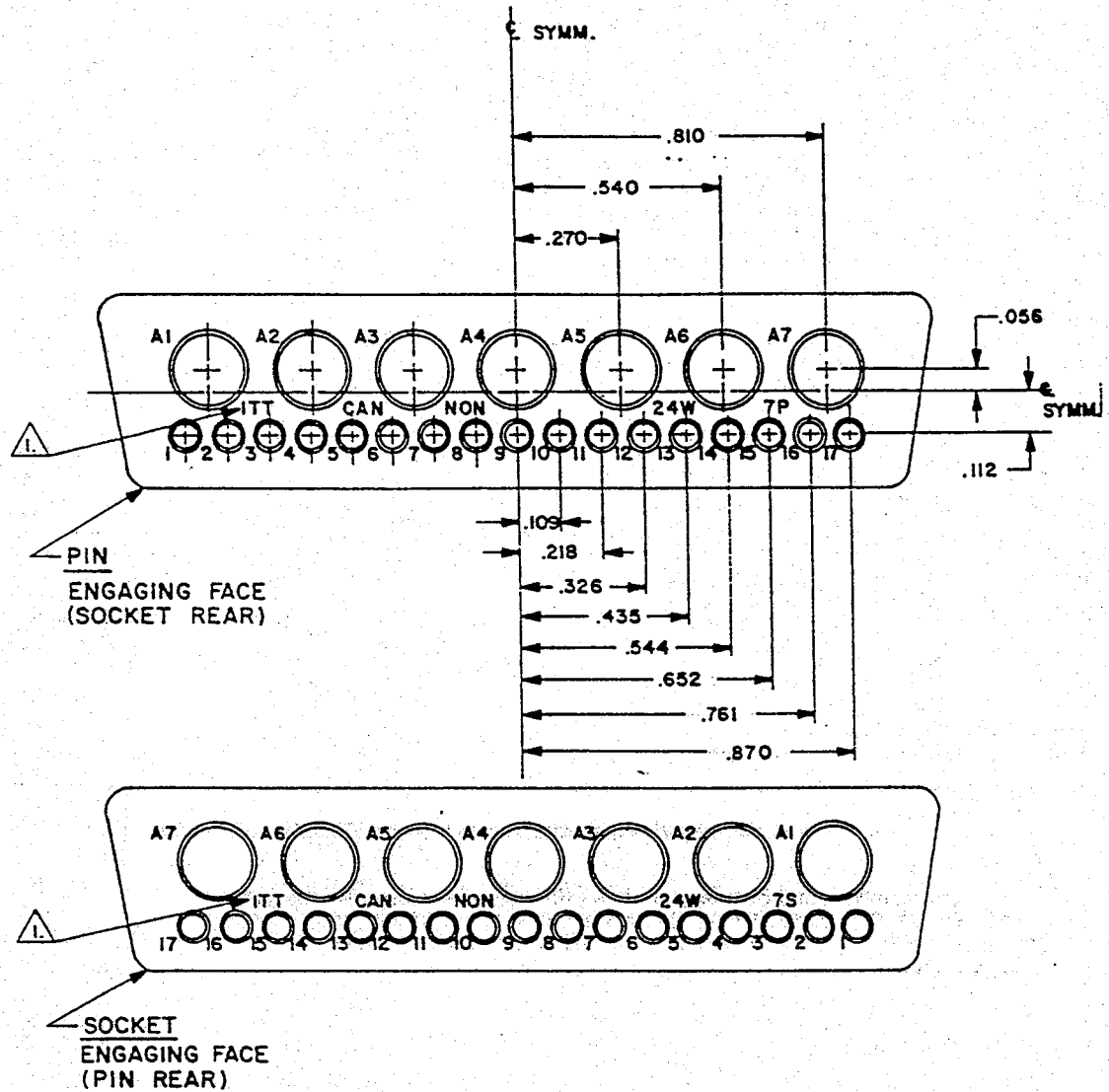
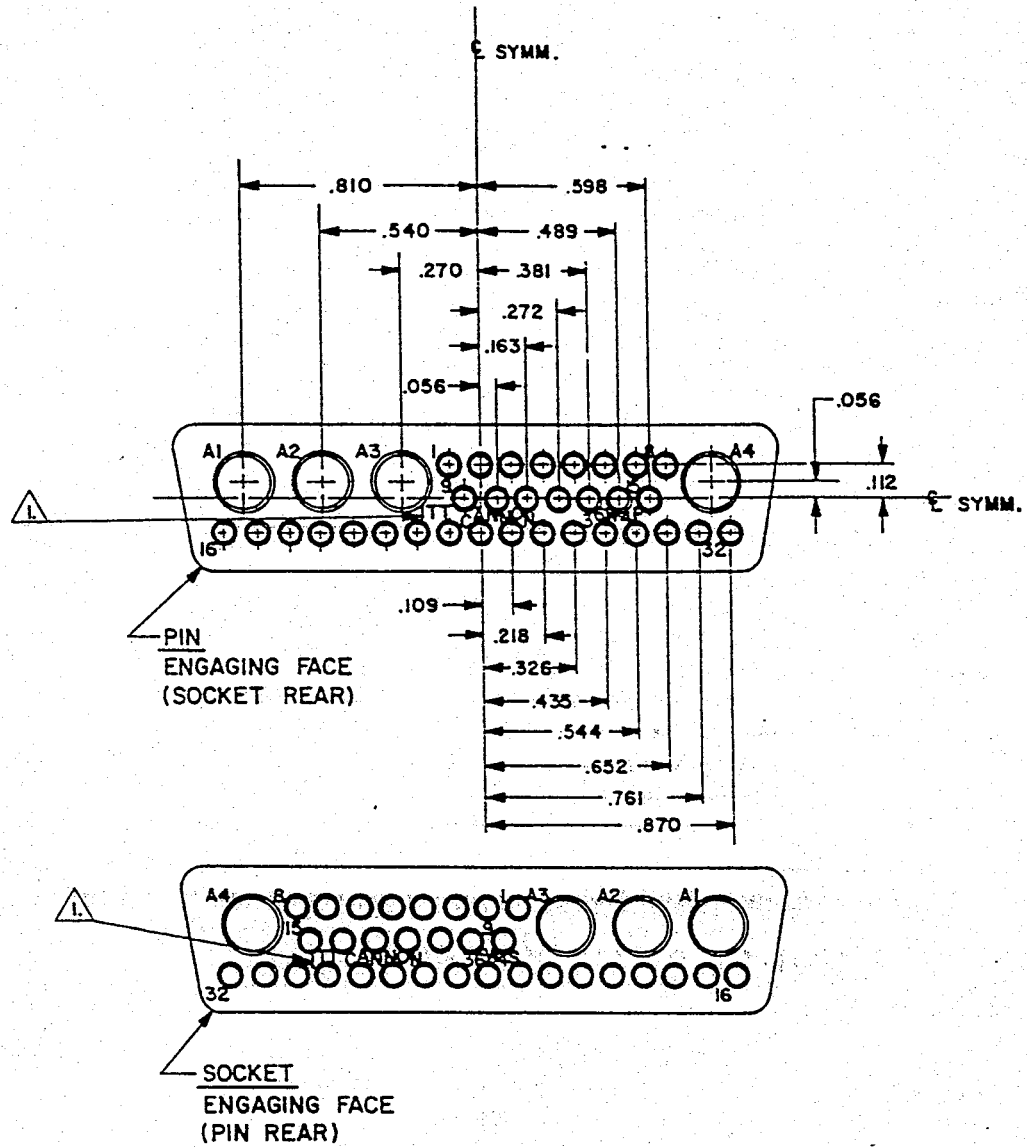

FIGURE 18 - INSERT ARRANGEMENT 22



1.  Manufacturer's name and manufacturer's insert part number (optional front and back of insert).
2. Contact hole locations are basic and T.P. within a .005 diameter at MMC (D+MA pin front and rear insulator holes must match within .003).
3. Insert arrangement in accordance with MS18277, except as shown.

FIGURE 19 - INSERT ARRANGEMENT 23



1. Manufacturer's name and manufacturer's insert part number (optional front and back of insert).
2. Contact hole locations are basic and T.P. within a .005 diameter at MMC (D+MA pin front and rear insulator holes must match within .003).
3. Insert arrangement in accordance with MS18277, except as shown.

FIGURE 20 - INSERT ARRANGEMENT 24

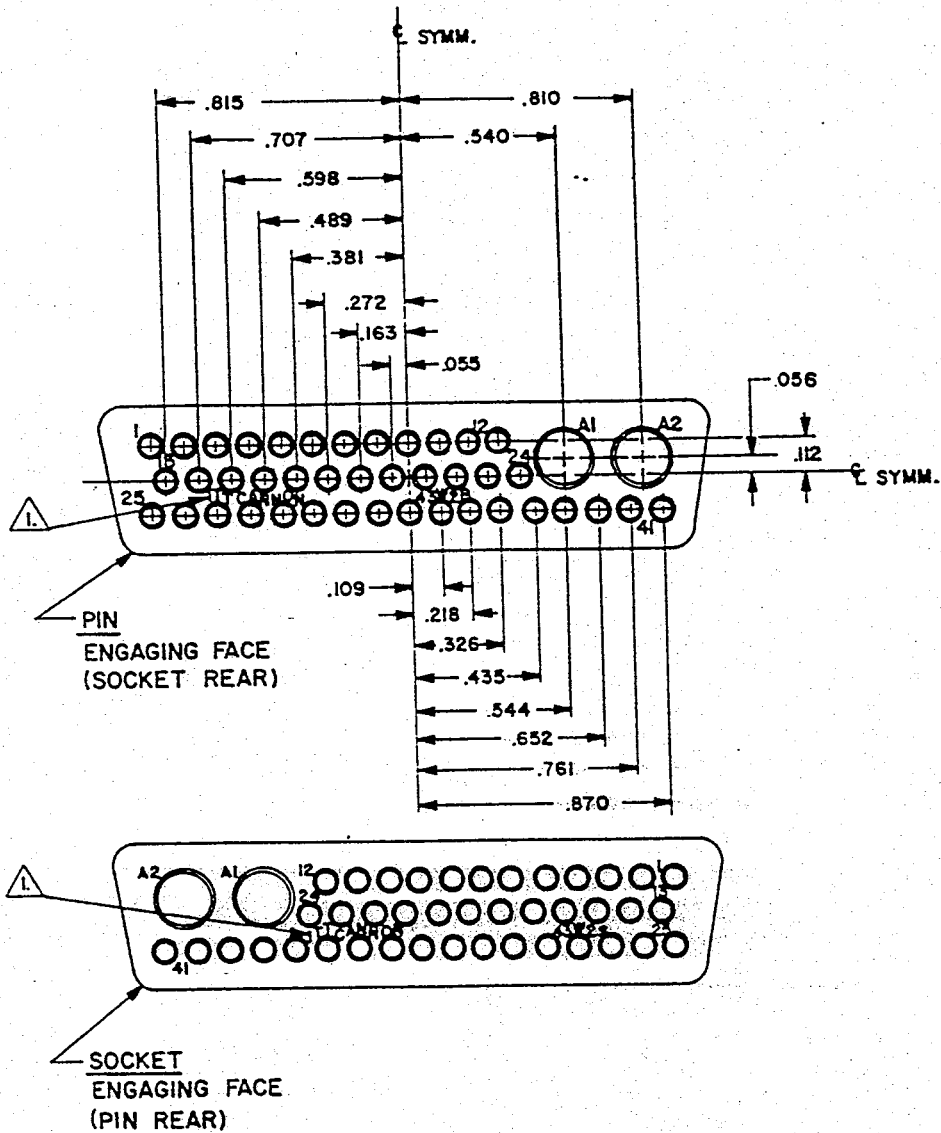
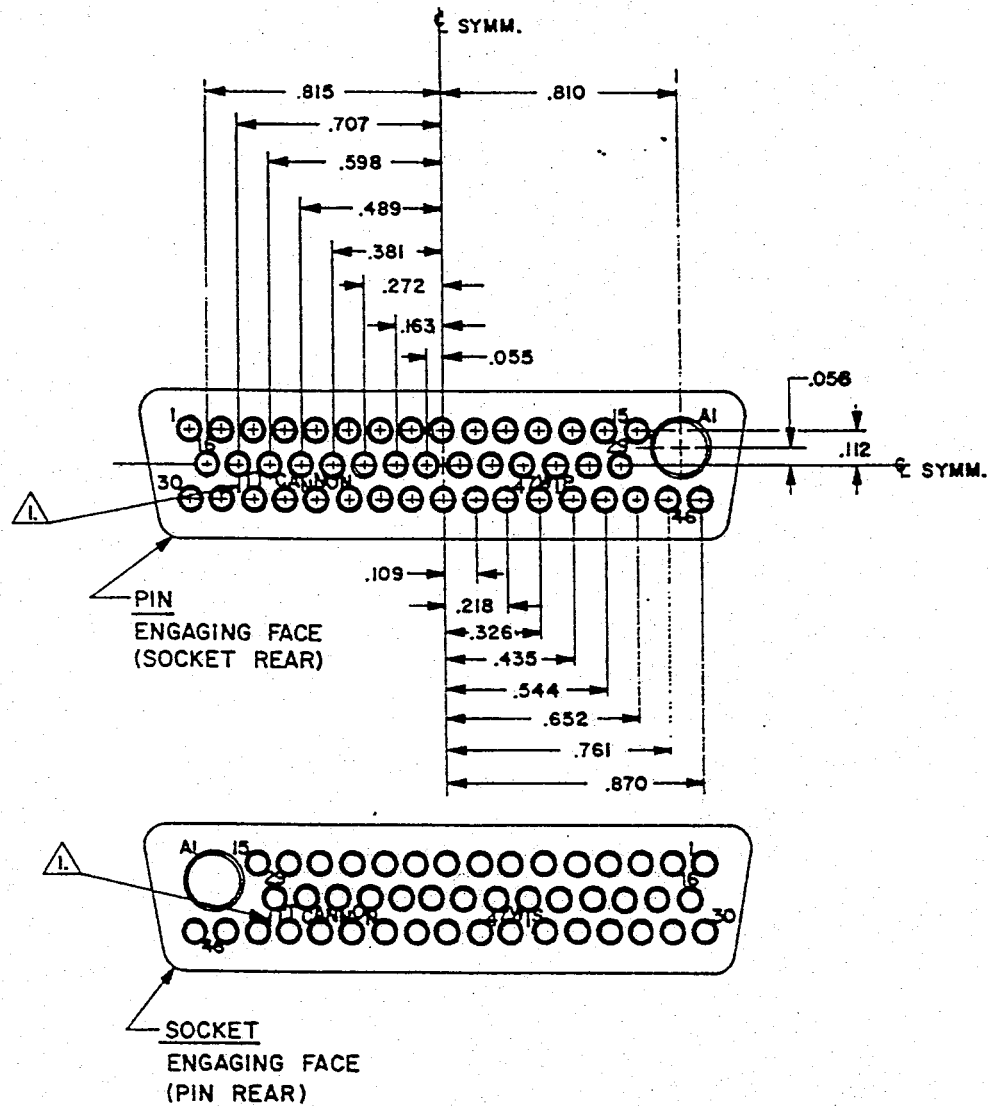

1.  Manufacturer's name and manufacturer's insert part number (optional front and back of insert).
2. Contact hole locations are basic and T.P. within a .005 diameter at MMC (D+MA pin front and rear insulator holes must match within .003).
3. Insert arrangement in accordance with MS18277, except as shown.

FIGURE 21 - INSERT ARRANGEMENT 25