

# **Standards for Radiation Effects Testing: Ensuring Scientific Rigor in the Face of Budget Realities and Modern Device Challenges**

**Jean-Marie Lauenstein, NASA/GSFC**

# Outline



- **Space Radiation Environment**
- **Radiation Effects**
- **Test Standards & Guidelines**
  - Drivers for and against change
- **Examples**
- **Conclusions**

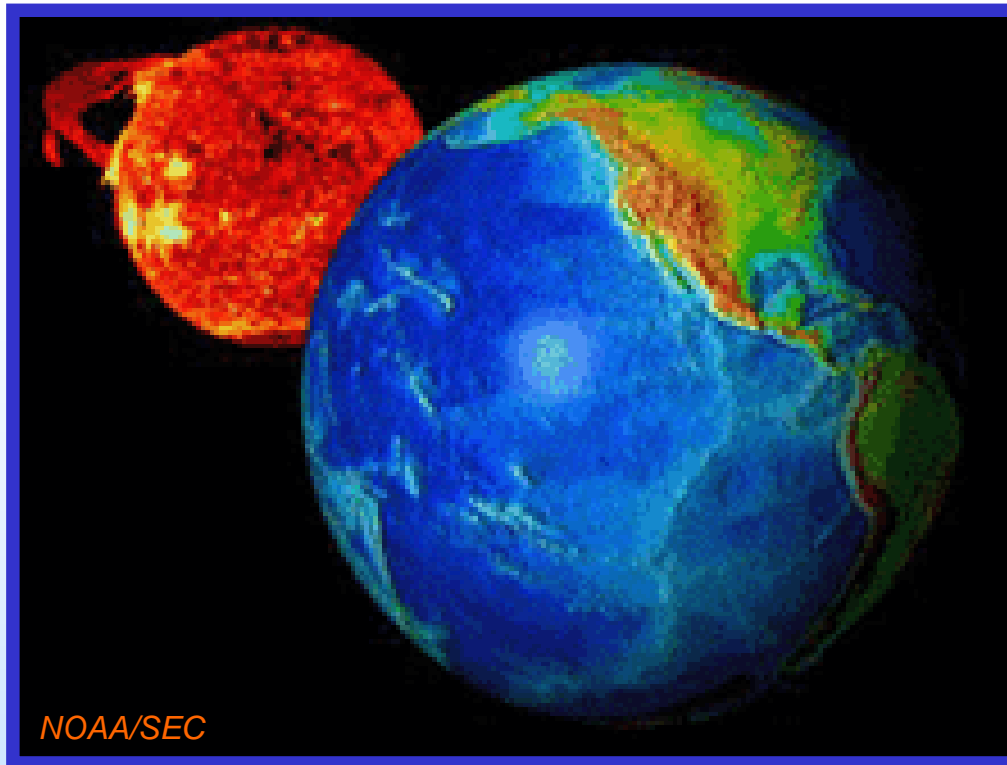

Part I:

# THE SPACE RADIATION ENVIRONMENT AND EFFECTS

# High Energy Radiation Particles

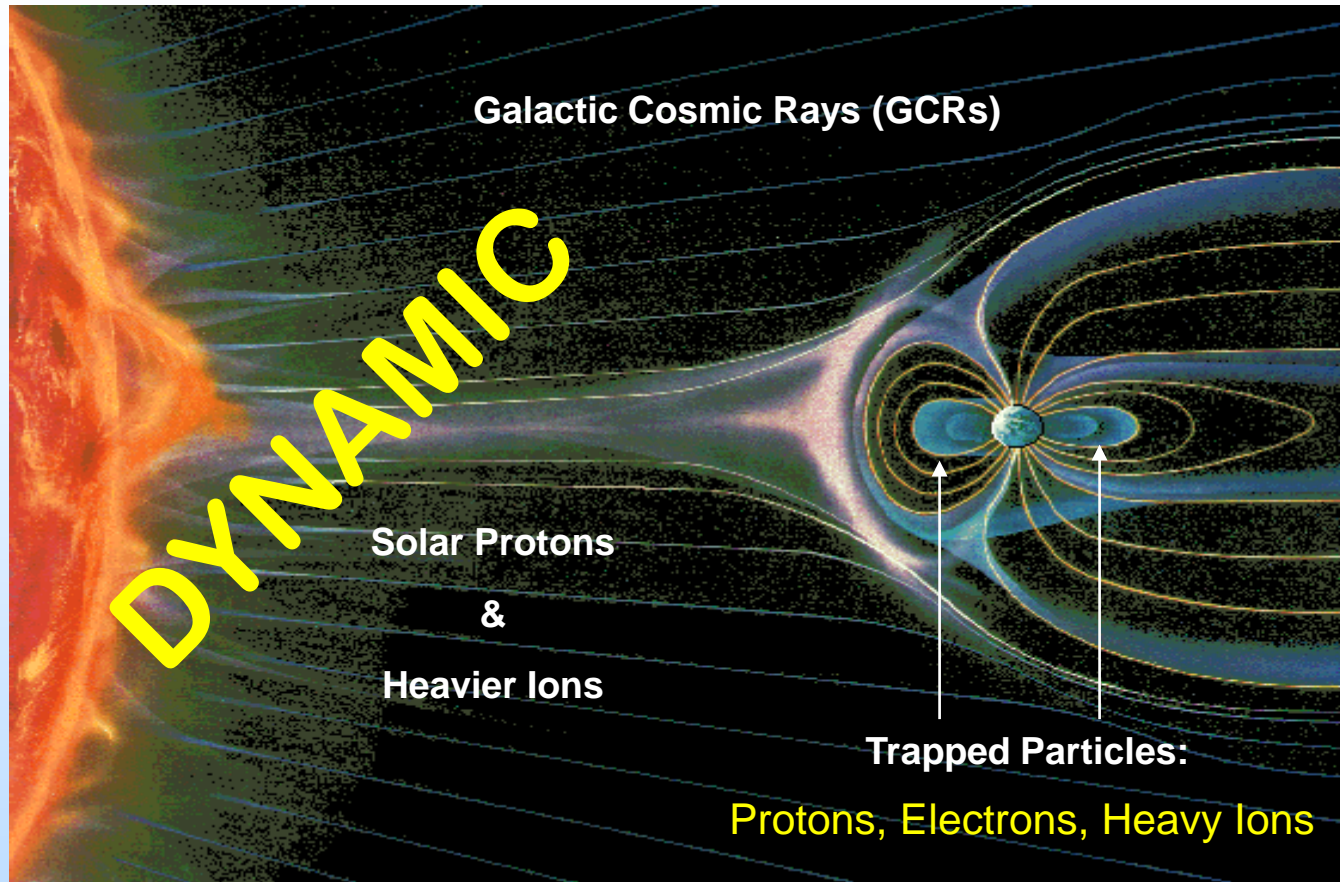

*After J. Barth, 1997 IEEE NSREC Short Course; K. Endo, Nikkei Science Inc. of Japan; and K. LaBel private communication.*

- **Deep-space missions may also see neutrons and gamma rays from background or radioisotope sources**

# Radiation Effects



- **Destructive SEE—Poisson process, constant rate, affect single die; redundancy effective as mitigation but very costly**
  - SEL—Single-Event Latchup (Complementary Metal Oxide Semiconductor-CMOS)
  - SEGR—Single-Event Gate Rupture (High-field MOS devices)
  - SEB—Single-Event Burnout in discrete transistors and diodes
  - Others—Stuck Bits, Snapback (Silicon on Insulator), Single-Event Dielectric Rupture
- **Nondestructive SEE—Poisson process, const. rate, single die, recoverable**
  - SEU—Single-Event Upset in digital device (or portion of device)
  - MBU/MCU—Multibit/Multi-Cell Upset in digital device (or portion)
  - SET—Single-Event Transient in digital or analog device
  - SEFI—Single-Event Functional Interrupt (full or partial loss of functionality)
- **Degradation Mechanisms—cumulative, end-of-life, affect most die as mission approaches mean failure dose; redundancy ineffective**
- TID—Total Ionizing Dose (degradation due to charge trapped in device oxides)
- DDD—Displacement Damage Dose (degradation from damage to semiconductor)

*\*SEE: Single-event effect*



**ASTM**

**U.S. Department  
of Defense**

**ESCC**  
European Space  
Components Coordination

**JEDEC**

**ANSI**  
American National  
Standards Institute

**IEC**

**Part II:**

# **TEST STANDARDS**

# Key Space Radiation Test Standards

Standard	Title	Date
JEDEC JESD57	Test Procedures for the Measurement of SEE in Semiconductor Devices from Heavy-Ion Irradiation	1996
JEDEC JESD234	Test Standard for the Measurement of Proton Radiation SEE in Electronic Devices	2013
MIL-STD-750-1	Environmental Test Methods for Semiconductor Devices TM 1017: Neutron irradiation TM 1019: Steady-state total dose irradiation procedure TM 1080: SEB and SEGR	2014
MIL-STD-883	Microcircuits TM 1017: Neutron irradiation TM 1019: Ionizing radiation (total dose) test procedure	2014
ESA-ESCC-25100	SEE Test Method and Guidelines	2014
ESA-ESCC-22900	Total Dose Steady-state Irradiation Test Method	2010

*(Prompt dose and terrestrial radiation standards not included)*

*\*TM = Test Method*

# Space Radiation Test Guidelines



Standard	Title	Date
ASTM F1192	Standard Guide for the Measurement of Single Event Phenomena (SEP) Induced by Heavy Ion Irradiation of Semiconductor Devices	2011
ASTM F1892	Standard Guide for Ionizing Radiation (Total Dose) Effects Testing of Semiconductor Devices	2012
ASTM F1190	Practice for the Neutron Irradiation of Unbiased Electronic Components	2011
MIL-HDBK-814	Ionizing Dose and Neutron Hardness Assurance Guidelines for Microcircuits and Semiconductor Devices	1994
Sandia Nat'l Lab. SAND 2008-6983P	Radiation Hardness Assurance Testing of Microelectronic Devices and Integrated Circuits: Test Guideline for Proton and Heavy Ion SEE	2008
Sandia Nat'l Lab. SAND 2008-6851P	Radiation Hardness Assurance Testing of Microelectronic Devices and Integrated Circuits: Radiation Environments, Physical Mechanisms, and Foundations for Hardness Assurance	2008
NASA/ DTRA	Field Programmable Gate Array (FPGA) Single Event Effect (SEE) Radiation Testing	2012

*(See ASTM website for additional guidelines)*



# Standard Rationale

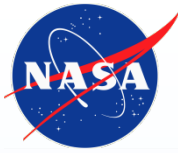

- **Standards & Guidelines are developed/ revised to:**
  - **Ensure tests follow best practices**
  - **Ensure results from different vendors/testers are comparable**
  - **Minimize and bound systematic and random errors**

***Data must be meaningful and must facilitate  
part selection and risk analysis***

***Best practices must be disseminated to  
new members of the test community***

# The Time Lag



- **Test standards & guidelines can (and often do) take years to develop or revise**
  - Widespread compliance can take additional years
- **Technology & research continuously evolve**

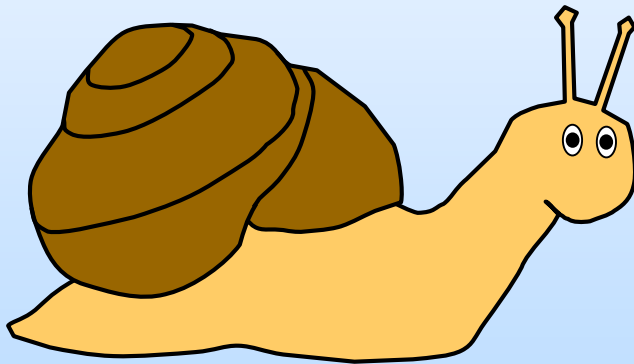

**Test Standards**

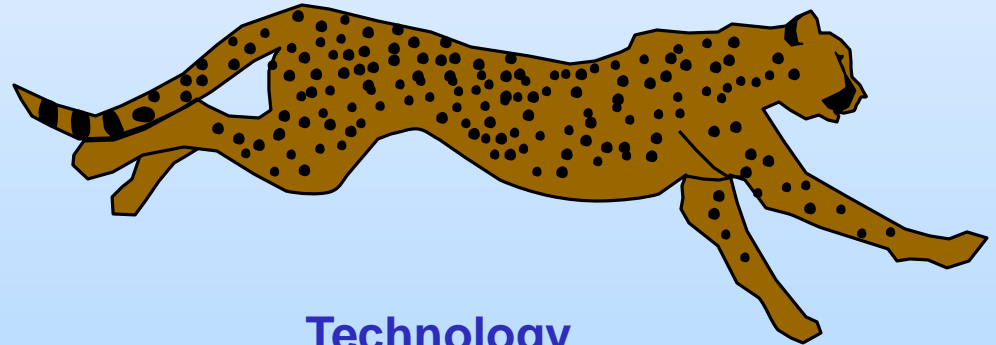

**Technology**

***The time lag is both useful and problematic***

Cartoon credits:  
[www.pixshark.com](http://www.pixshark.com)

# Balancing Act



- **4 drivers of development/revision:**
  - New technologies requiring new methods for testing
  - New failure mechanisms or new research on known mechanisms
  - New radiation hardness assurance methods
  - New applications of existing technology
- **4 counterbalances to change:**
  - Cost (time and money)
  - Consensus/weight of evidence
  - Device complexity (note: can push both ways)
  - Pre-existing products and designs

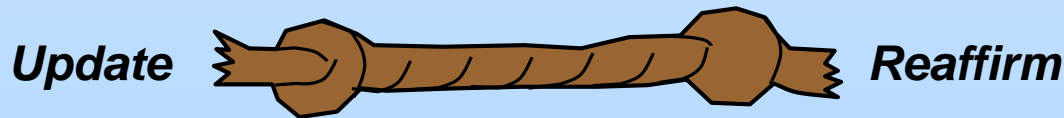

**Standards Tug-of-War**

# Example 1: ELDRS

- **ELDRS = Enhanced Low Dose Rate Sensitivity**
  - Amount of total dose degradation at a given total dose is greater at low dose rates (LDR) than at high dose rates (HDR)
- **Low dose rate enhancement factor (LDR EF)**

$$\text{LDR EF} = \frac{\Delta \text{Parameter Low Dose Rate}}{\Delta \text{Parameter High Dose Rate}}$$
- **MIL-STD-883G TM 1019: part is ELDRS susceptible if LDR EF  $\geq 1.5$  and parameter is above pre-irradiation specification limits**

## $I_{B+}$ vs. Total Dose for LM111 Voltage Comparators

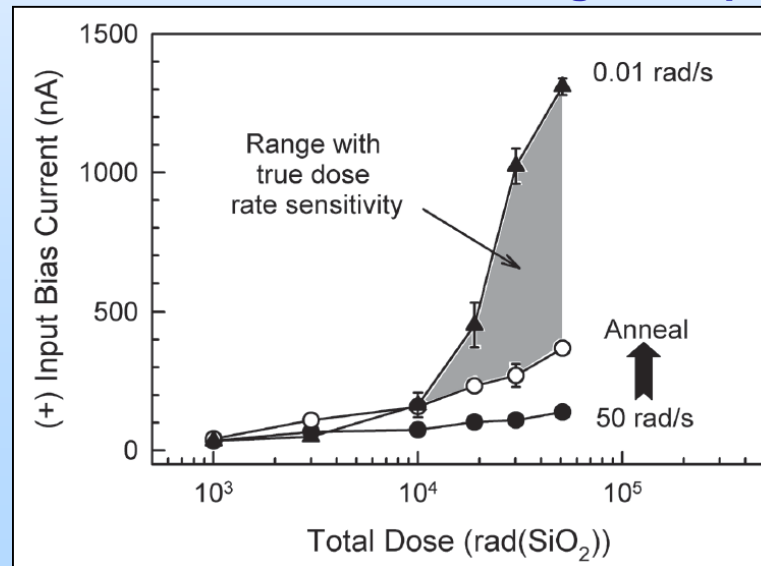

M. R. Shaneyfelt, et al., *IEEE TNS*, 2000.

# Example 1: ELDRS in LM117

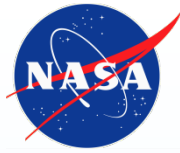

- **History: LM117 deemed “ELDRS free” under MIL-STD-883 TM1019 Condition D:**
  - $\leq 10$  mrad(Si)/s dose rate for bipolar or BiCMOS linear or mixed-signal devices
- **Driver for change: new research on known mechanisms**
  - Exhibits increasing degradation with decreasing dose rates  $< 10$  mrad(Si)/s
  - “Ultra ELDRS” : parameter out of spec at LDR  $\leq 1$  mrad(Si)/s

TEXAS INSTRUMENTS LM117QML LM117QML-SP

LM117QML 3-Terminal Adjustable Regulator

**FEATURES**

- Available with Radiation Ensured
  - High Dose Rate 100 krad(Si)
  - ELDRS Free 100 krad(Si)
- Specified max. 0.2% Load Regulation (LM117)
- Specified 0.5A or 1.5A Output Current
- Adjustable Output Down to 1.2V

**DESCRIPTION**

The LM117 series of adjustable 3-terminal positive voltage regulators is capable of supplying either 0.5A or 1.5A over a 1.2V to 37V output range. They are exceptionally easy to use and require only two external resistors to set the output voltage. Further, both line and load regulation are better than standard fixed regulators.

In addition to higher performance than fixed series offers full overload protection and safe load protection circuitry even if the adjustment is needed unless the device is bypassed from the input filter in input bypass is needed, it can be added to improve adjustment terminal can be high ripple rejection ratios with standard 3-terminal regulators, the LM117 is used in other applications. Since it uses only the input-to-output supplies of several hundred volts can be regulated as long as the maximum input to output differential is not exceeded, i.e., avoid short-circuiting the output.

Also, it makes an especially simple adjustable switching regulator, a programmable output regulator, or by connecting a fixed resistor between the adjustment pin and output, the LM117 can be used as a precision current regulator. Supplies with electronic shutdown can be achieved by clamping the adjustment terminal to ground which programs the output to 1.2V where most loads draw little current.

For the negative complement, see LM137 series data sheet.

Please be aware that an important notice concerning availability, standard warranty, and use in critical applications of Texas Instruments semiconductor products and disclaimers thereon appear at the end of this data sheet.

## FEATURES

- Available with Radiation Ensured
  - High Dose Rate 100 krad(Si)
  - ELDRS Free 100 krad(Si)

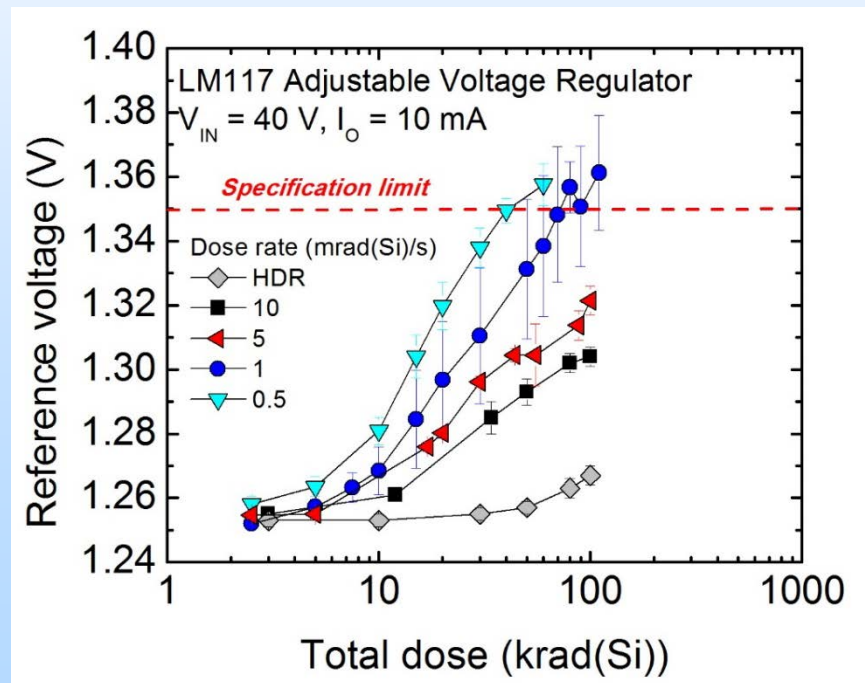

Chen, D., et al., *IEEE TNS* 2011; updated 2015.

# Example 1: ELDRS cont'd



- Ultra-ELDRS is not isolated to LM117:

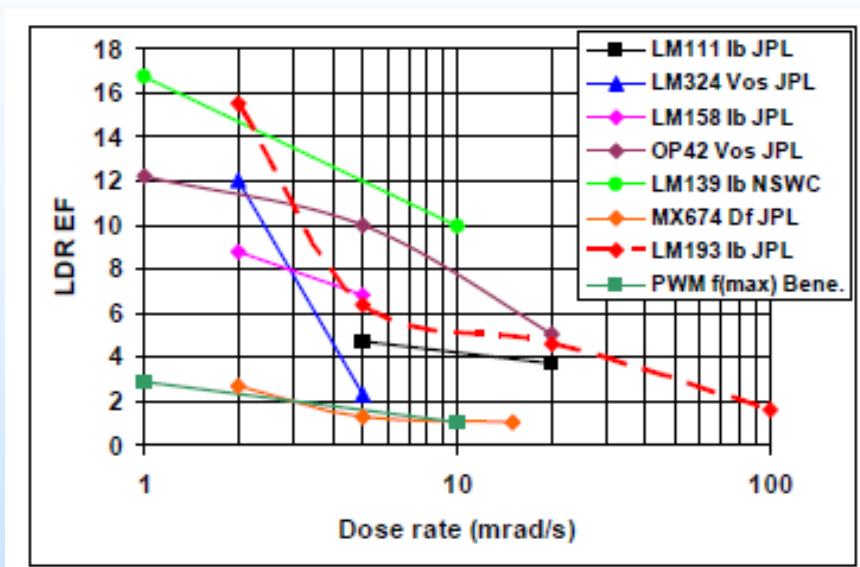

From Pease, R.L., IEEE TNS, 2009

***Should the test standard be revised?***

# Example 1: ELDRS cont'd



- **Challenges for hardness assurance**
  - Applying a constant overtest factor to the specification dose for a 10 mrad(Si)/s irradiation test may not bound the degradation for all parts
    - *No easy solution*
  - Test at the mission required dose rate?
  - Test at a dose rate lower than 10 mrad(Si)/s?
- **Counterbalance:**
  - **Cost:** Already takes 2 months for 50 krad(Si) at 10 mrad(Si)/s
  - **Consensus:** Significance of risk still under debate
  - **Pre-existing products and designs:**
    - Retest/requal costs,
    - Ability to track lot-lot variations lost until history developed under new test conditions

# Example 2: More ELDRS



- MIL-STD-750-1 TM1019: No “Condition D” low dose rate req’ts
- History: Discrete bipolar junction transistors (BJTs) do not exhibit ELDRS
- Driver for change: new research on known mechanisms
  - Some discrete BJTs demonstrate ELDRS of current gain degradation

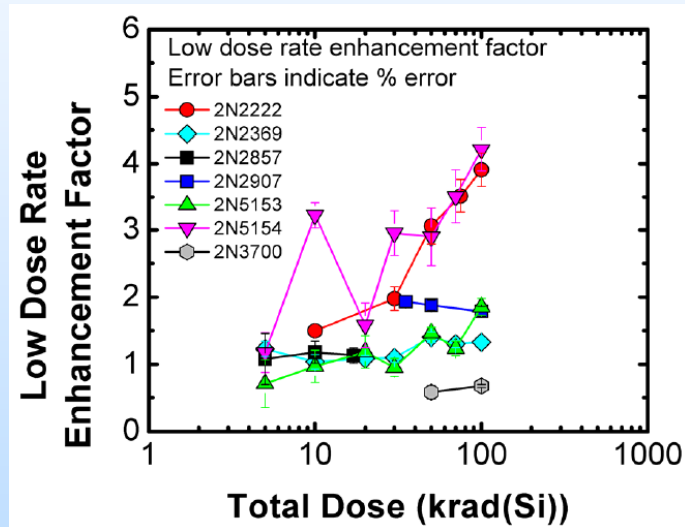

D. Chen, et al., *IEEE REDW*, 2012.

- Radiation Hardness Assurance (RHA) challenge: ELDRS for BJTs of similar process technology varies widely
- Counterbalance: Cost, consensus, and pre-existing devices
  - How widespread is the susceptibility?



# Example 3: SEGR

- **SEGR = Single event gate rupture:**
  - In power MOSFETs, ion energy, species, and angle of incidence affect device susceptibility
    - *Not a simple cross section vs. linear energy transfer (LET) problem*
- **History: Characterization of a “safe operating area” (SOA) for off-state voltages in terms of LET**

## SEGR in a typical planar vertical power MOSFET (VDMOS)

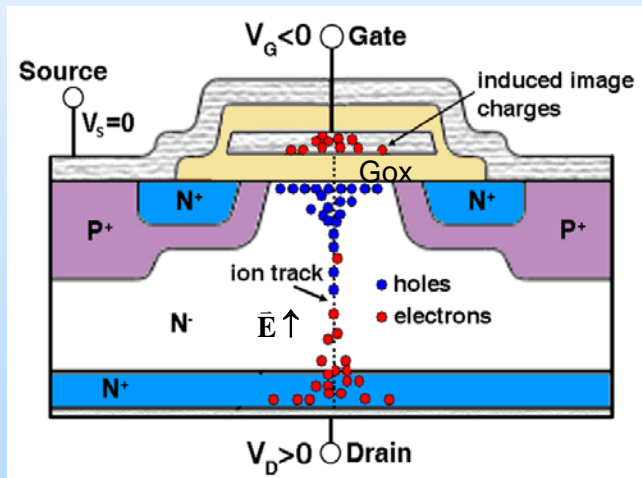

Modified from: Allenspach, et al., *IEEE TNS* 1994.

## Example “Safe operating area”

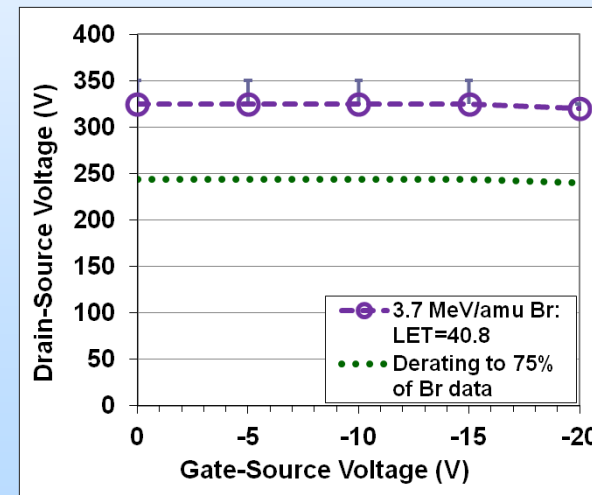

Lauenstein, *NEPP Electronic Data Workshop*, 2012.

MOSFET = metal oxide semiconductor field effect transistor

# Example 3: SEGR cont'd



- **Driver for change: new research on known mechanisms**

- 1996: ion penetration range (energy) affects susceptibility
- 2001: worst-case energy for given ion defined

- **MIL-STD-750E (2006) incorporates this effect:**

*“Data points are taken to describe the response of the discrete MOSFET as a function of  $V_{GS}$  and/or  $V_{DS}$  over the operating range of the device and/or **over a range of LET values.**”*

**Later in the test procedure:** *“Also, note that the **energy of the ion beam** has been shown to influence the SEGR failure thresholds. Therefore, **determination of the worst case test condition** can require multiple irradiations with the same ion at different energies.”*

## Energy (Range) Effects on SOA

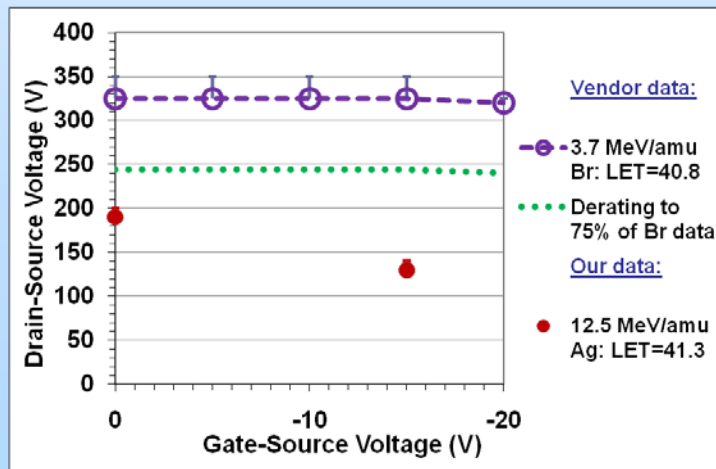

- **Impact to pre-existing devices:**

- “SOA” relabeled as “Single Event Effect Response Curve” for a given beam condition.
- *Worst-case test condition still not adopted due to cost of re-qual*

# Example 3: SEGR cont'd

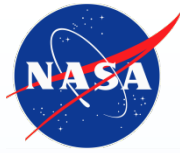

- **Driver for further change: Multiple manufacturers**
  - Different device geometries demand true worst-case beam conditions for cross-manufacturer comparisons
- **MIL-STD-750-1 (2012) incorporates worst-case conditions:**

“For SEGR, the *worst-case test condition for the ion* occurs when the ion fully penetrates the epitaxial layer(s) with maximum energy deposition through the entire epitaxial layer(s).”

“NOTE 23: SEGR characterization *curves may be better expressed as a function of ion species (atomic number)* instead as a function of LET. Ion beam characteristics shall be included with the response curves (ion LET at die surface, ion species, and ion energy).”

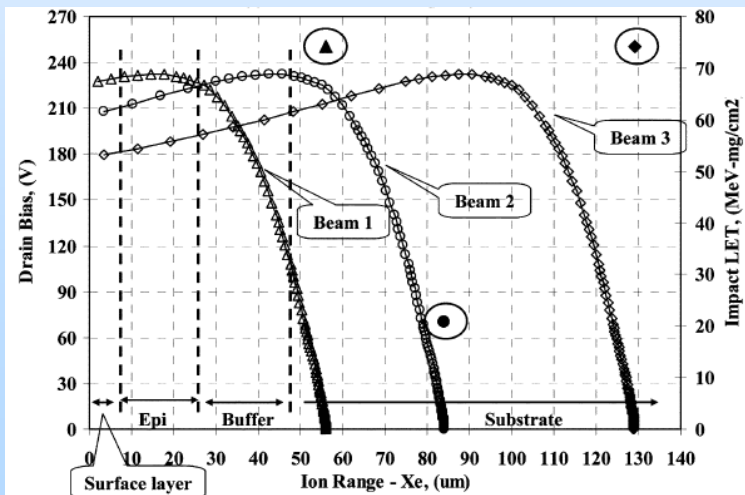

- **Impact to pre-existing devices:**
  - Requalification
  - Oldest generation no longer advertised for space applications
- **JESD57 (1996) still LET-based**
  - Under revision

Liu, et al., *IEEE TNS*, 2010.

## Worst-case ion energy: Beam 2

# Example 4: more SEGR



- **Driver: New application of existing technology**
  - Demand for rate estimation when risk avoidance not possible
    - ex/ high-performance applications or commercial boards
- **Counterbalance: Lack of consensus on failure rate prediction methods**
  - 6 proposed methods in the literature – none validated
  - Require different kinds of test data

## Operating Outside the “SOA” Requires Failure Rate Estimation

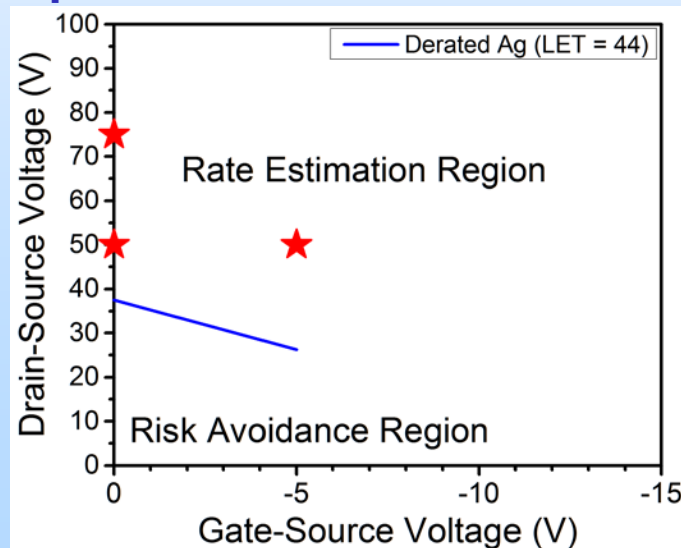

Lauenstein, et al., IEEE NSREC 2014

# Example 5: Advanced Electronics



- **History: SEE test guidelines and standards geared toward simpler devices/circuits**
- **Driver for change: New technologies, failure modes, & research**
  - Proton direct-ionization induced SEE
  - Variation of susceptibility with roll angle in addition to tilt angle
  - Expansion of single-event functional interrupt definition
  - High-speed applications (require high-speed test capability)
  - Increasing number of modes of operation of complex devices
  - ....

## Low-energy protons upset 65 nm Silicon-on-Insulator SRAM

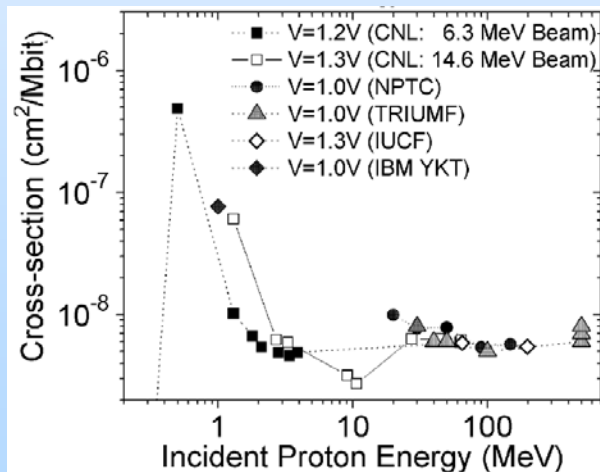

D. F. Heidel, *et al.*, *IEEE TNS*, Dec. 2008.

## Effective LET not effective for 90 nm CMOS latch

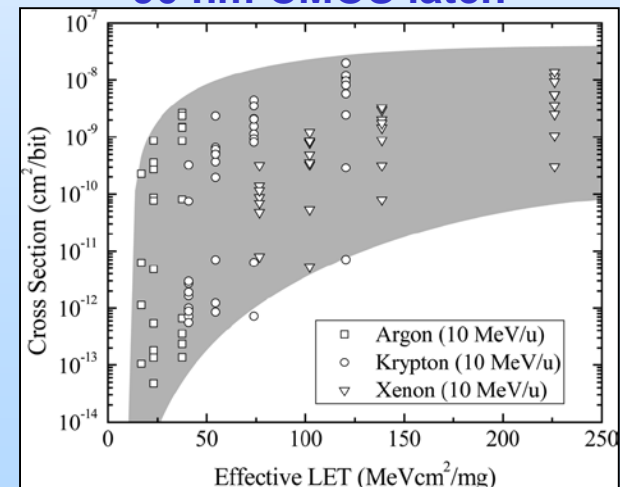

K. M. Warren, *et al.*, *IEEE TNS*, 2007

\*SRAM = static random-access memory

# Example 5: Advanced Electronics

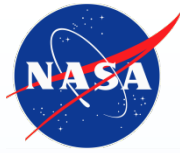

- **Counterbalance: Cost, complexity**
- **How do we incorporate advanced electronics SEE testing into SEE test standards?**
  - Proton SEE test standard (JESD234) released
  - Revision of JESD57 is an opportunity for inclusion of more established methods for testing advanced electronics
  - Highly complex technologies will benefit from specific guidelines
    - ex/ NASA FPGA test guideline
  - Complex devices incorporate many modes and functions
    - Test results depend on how we test the device
    - The bleeding edge of testing is generalizing application specific test results to bound flight performance at all stages of the mission

**High-Speed Test Fixture**

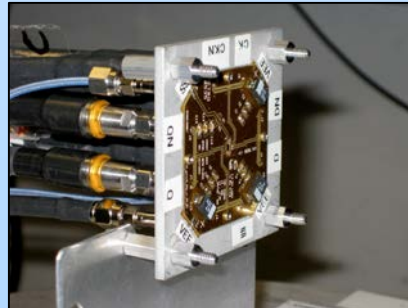

Photo credit: J. A. Pellish, NASA GSFC, 2013

# Summary



- **Because radiation hardness assurance is dynamic, test standards and guidelines will always be “behind the times”**
- **Continued development of test standard/guideline updates facilitates technical rigor and mission confidence and success**

**But...**

- **Test standards are a compromise between technical rigor and economic realities**
  - **The goal is to be good enough to ensure success and cheap enough that the standards & guidelines will actually be used**