



NASA Past, Present, and Future: The Use of Commercial Off The Shelf (COTS) Electronics in Space

**Kenneth A. LaBel,
NASA Electronic Parts and Packaging (NEPP) Co-Manager
ken.label@nasa.gov
301-286-9936**

**Steven M. Guertin
steven.m.guertin@jpl.nasa.gov
818-393-6895**

Acknowledgment:

This work was sponsored by:

NASA Office of Safety & Mission Assurance

Open Access



Acronym List

- **Command and Data Handling (CADH)**
- **Consultative Committee for Space Data Systems (CCSDS)**
- **Commercial Off The Shelf (COTS)**
- **Dynamic Random Access Memory (DRAM)**
- **Error Detection and Correction (EDAC)**
- **Electrical, Electronic and Electromechanical (EEE)**
- **Geosynchronous Equatorial Orbit (GEO)**
- **Goddard Space Flight Center (GSFC)**
- **Integrated Circuits (ICs)**
- **International Space Station (ISS)**
- **NASA Jet Propulsion Laboratory (JPL)**
- **Low Earth Orbit (LEO)**
- **Military/Aerospace (Mil/Aero)**
- **Mars Science Lander (MSL)**
- **NASA Electronic Parts and Packaging (NEPP) Program**
- **printed circuit boards (PCBs)**
- **physics of failure (PoF)**
- **real-time operating system (RTOS)**
- **Solar Anomalous Magnetospheric Particle Explorer (SAMPEX)**
- **Synchronous Dynamic Random Access Memory (SDRAM)**
- **Small Explorer Data System (SEDS)**
- **Single Event Effects (SEE)**
- **single event functional interrupts (SEFIs)**
- **single event upset (SEU)**
- **Small Explorer (SMEX)**
- **surface mount technology (SMT)**
- **Static Random Access Memory (SRAM)**
- **Solid State Recorders (SSRs)**
- **Size, Weight, and Power (SwaP)**
- **Ultraviolet (UV)**
- **Virtual Real-Time Executive (VRTX)**



Abstract/Outline

- **NASA has a long history of using commercial grade electronics in space. In this presentation**
- **We will provide a brief history of NASA's trends and approaches to commercial grade electronics focusing on processing and memory systems.**
 - **This will include providing summary information on the space hazards to electronics as well as NASA mission trade space.**
 - **We will also discuss developing recommendations for risk management approaches to Electrical, Electronic and Electromechanical (EEE) parts usage in space.**
 - **Two examples will be provided focusing on a near-earth Polar-orbiting spacecraft as well as a mission to Mars.**
 - **The final portion will discuss emerging trends impacting usage.**



Sample Space Hazards by Orbit Type

| | Plasma (charging) | Trapped Protons | Trapped Electrons | Solar Particles | Cosmic Rays | Human Presence | Long Lifetime (>10 years) | Nuclear Exposure | Repeated Launch | Extreme Temperature | Planetary Contaminates (Dust, etc) |
|---------------------------|----------------------------------------------|----------------------------------------------|----------------------------------------------|-----------------|-------------|----------------|---------------------------|------------------|-----------------|---------------------|------------------------------------|
| GEO | Yes | No | Severe | Yes | Yes | No | Yes | No | No | No | No |
| LEO (low-incl) | No | Yes | Moderate | No | No | No | Not usual | No | No | No | No |
| LEO Polar | No | Yes | Moderate | Yes | Yes | No | Not usual | No | No | No | No |
| Shuttle | No | Yes | Moderate | No | No | Yes | Yes | No | Yes | Rocket Motors | No |
| ISS | No | Yes | Moderate | Yes - partial | Minimal | Yes | Yes | No | No | No | No |
| Interplanetary | During phasing orbits; Possible Other Planet | During phasing orbits; Possible Other Planet | During phasing orbits; Possible Other Planet | Yes | Yes | No | Yes | Maybe | No | Yes | Maybe |
| Exploration - Vehicles | Phasing orbits | During phasing orbits | During phasing orbits | Yes | Yes | Yes | Yes | No | Yes | Rocket Motors | No |
| Exploration – Lunar, Mars | Phasing orbits | During phasing orbits | During phasing orbits | Yes | Yes | Yes | Yes | Maybe | No | Yes | Yes |

Note that this is not a complete space hazard list.

Other items such as operation in a vacuum, UV exposure, etc... aren't included.

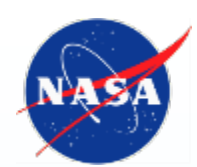

Assurance for EEE Parts

- **Assurance** is
 - Knowledge of
 - The supply chain and manufacturer of the product,
 - The manufacturing process and its controls, and,
 - The physics of failure (PoF) related to the technology.
 - Statistical process and inspection via
 - Testing, inspection, physical analyses and modeling.
 - Understanding the application and environmental conditions for device usage.
 - This includes:
 - Radiation,
 - Lifetime,
 - Temperature,
 - Vacuum, etc., as well as,
 - Device application and appropriate derating criteria.



Reliability and Availability

- **Reliability (Wikipedia)**
 - The ability of a system or component to perform its required functions under stated conditions for a specified period of time.
- **Availability (Wikipedia)**
 - The degree to which a system, subsystem, or equipment is in a specified operable and committable state at the start of a mission, when the mission is called for at an unknown, *i.e.*, a random, time. Simply put, availability is the proportion of time a system is in a functioning condition. This is often described as a ***mission capable rate***.
- **The bottom line:**
 - ***Does it work as expected for as long as needed and when it's needed!***



NASA COTS Challenges

- **Unique Space Usage Constraints**
 - Environment hazards
 - Servicing (limited options)
 - Wide range of mission lifetimes and orbits
 - System availability (not just reliability) requirements (criticality of function and timing)

Solution Details



| | COTS | Q100 | EP | QMLQ | Space EP* | Space-QMLV |
|---------------------------------|--------------|---------------|--------------------------|---------------|---------------|---------------|
| Packaging | Plastic | Plastic | Plastic | Ceramic | Plastic | Ceramic |
| Single Controlled Baseline | No | No | Yes | Yes | Yes | Yes |
| Bond Wires | Au/Cu | Au/Cu | Au | Al | Au | Al |
| Is Pure Sn used? | Yes | Yes | No | No | No | No |
| Guaranteed Rad Performance | No | No | No | No | Yes | Yes |
| Typical Temp Range | -40°C - 85°C | -40°C - 125°C | -55°C - 125°C (majority) | -55°C - 125°C | -55°C - 125°C | -55°C - 125°C |
| Extra Qual and Process Monitors | No | Yes | Yes | Yes | Yes | Yes |
| Life Test Per Wafer Lot | No | No | No | No | Yes | Yes |
| Orderable by Single Lot | No | No | No | Yes | TBD | Yes |

*Space EP currently in definition

Used by permission from the author, Robert Baumann, "From COTS to Space - Grade Electronics: Improving Reliability for Harsh Environments," 2016 Single Event Effects (SEE) Symposium and the Military and Aerospace Programmable Logic Devices (MAPLD) Workshop, La Jolla, CA, May 23-26, 2016.

For a small market (compared to commercial), space electronics place big demands on the semiconductor manufacturer.



NASA Historically Uses Mil/Aero Grade

- **Prime reason has been the detailed and relevant knowledge about the performance and reliability of the actual parts to be flown.**
- **Mil/Aero uses a standardized set of manufacturer qualification tests that provide confidence in a device's reliability for a wide range of space conditions.**
 - **The test levels are set such that they bound the majority of environment and lifetime exposures for space missions with the exception of extreme environments and, in some cases, radiation tolerance.**
 - **Mil/Aero also allows manufacturers to perform one set of qualification tests rather than a tailored set for each specific mission environment and lifetime profile.**
 - **As noted already, other industries such as automotive and medical have their own sets of screening and qualification levels.**



The Move to COTS in Space

- Up until 1990 timeframe, NASA used COTS mainly in cases where no Mil/Aero alternative existed or in non-critical applications.
- However, key performance parameters (size, weight, and power – SwaP as well as processing system performance) began to drive the usage of COTS into mainstream applications within the Agency.
- **Example: the history of space data recorders**
 - 1960's-70's - Magnetic Core Memory
 - 1970's-80's - Magnetic Tape Recorder
 - 1990's - Solid State Recorders (SSRs) – Static Random Access Memory (SRAM)
 - Late 1990's - SSR – Dynamic Random Access Memory (DRAM)
 - Early 2010's - SSR – FLASH



NASA's Traditional Approach to Using COTS Electronics

- **The classic approach was to upscreen:**
 - Perform a series of tests over extended environment/lifetime parameters coupled with application usage information to determine if a part can meet a mission's reliability/availability constraints.
 - This includes temperature, vacuum, radiation, shock, vibration, etc...
- **While the confidence in the reliability/availability of this approach may be less than electronics designed for the harsh space environment, sufficient risk reduction may be achieved.**
 - Starting around 1990, NASA missions that had multi-year operation or significant radiation requirements began coupling COTS parts into systems usually with a salient mix of Mil/Aero parts and fault tolerant architectures.



Example 1: Solar Anomalous Magnetospheric Particle Explorer (SAMPEX)

- On November 13, 2012, the SAMPEX spacecraft reentered the earth's atmosphere.*
- SAMPEX, the first of NASA's Small Explorer (SMEX) spacecraft, was launched in 1992 with a three year design *lifetime* (5 year goal).
- It lasted operationally nearly twenty years due to a myriad of testing, electronic parts selection, and system architecture, thrilling the scientific investigators who were able to obtain tremendous new scientific data.
- One should note that the entire spacecraft was designed, built, and validated in three years (1989-1992) by NASA.
 - It's orbit was a slightly eccentric low earth polar orbit.



https://www.nasa.gov/images/content/700355main_sampex_full.jpg

* = Karen C. Fox, "NASA's SAMPEX Mission: A Space Weather Warrior," NASA/GSFC, Nov. 01,2012, http://www.nasa.gov/mission_pages/sunearth/news/sampex-deorbit.html



SAMPEX's Command and Data Handling (CADH) System - The Small Explorer Data System (SEDS)

- **SEDS was built upon traditionally competing ideas:**
 - Increasing spacecraft performance, and,
 - Having a high reliability/availability spacecraft.
- **This led, in itself, to two concepts for the CADH:**
 - Selection of commercial and new electronics technologies, and,
 - Detailed evaluation (technology), qualification, and validation planning.
- **The SEDS approach became the cornerstone philosophy and system design for generations of spacecraft that followed.**



The SEDS Architecture

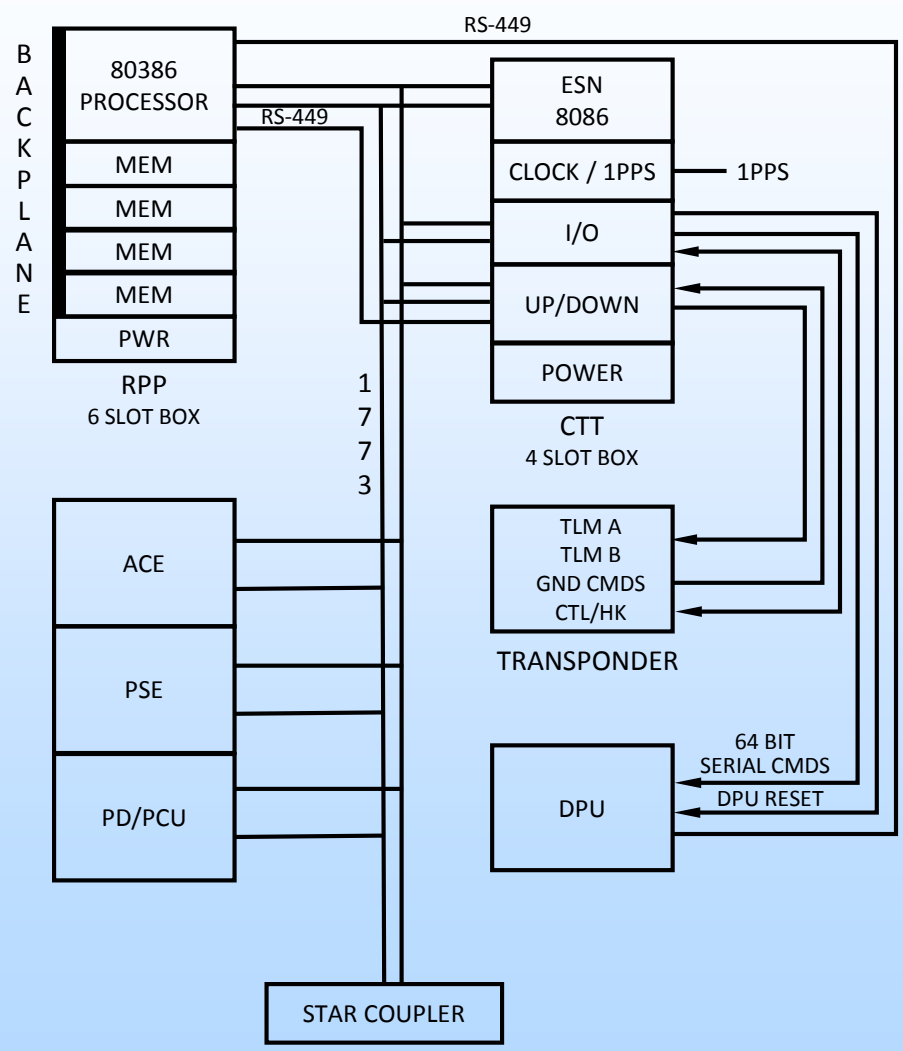

after D. N. Baker, et al, "The Solar, Anomalous, and Magnetospheric Particle Explorer (SAMPEX) Mission," IEEE Transactions on Geoscience and Remote Sensing, Vol. 31, No. 3, May 1993, pp. 531-541



SEDS Technology: Fiber Optics

- **Development and first use of a fiber optic data bus (MIL-STD-1773).**
 - This included selection and testing of the optical and electrical components, protocol electronics, connectors, couplers, and optical fiber.
 - Radiation testing was partnered with U.S. Department of Defense (DoD) (Naval Research Labs) which has led to continued collaboration between our organizations.
- **MIL-STD-1773 was also the first NASA move away from traditional custom parallel bus structures for data/command transfer to serial bus structure.**
 - This simplified interconnects and was a size, weight, and power (SWAP) savings breakthrough.
 - The underlying electrical protocol, MIL-STD-1553, is still in common use across the space industry and paved the way for newer generations of databus implementations such as SpaceWire.

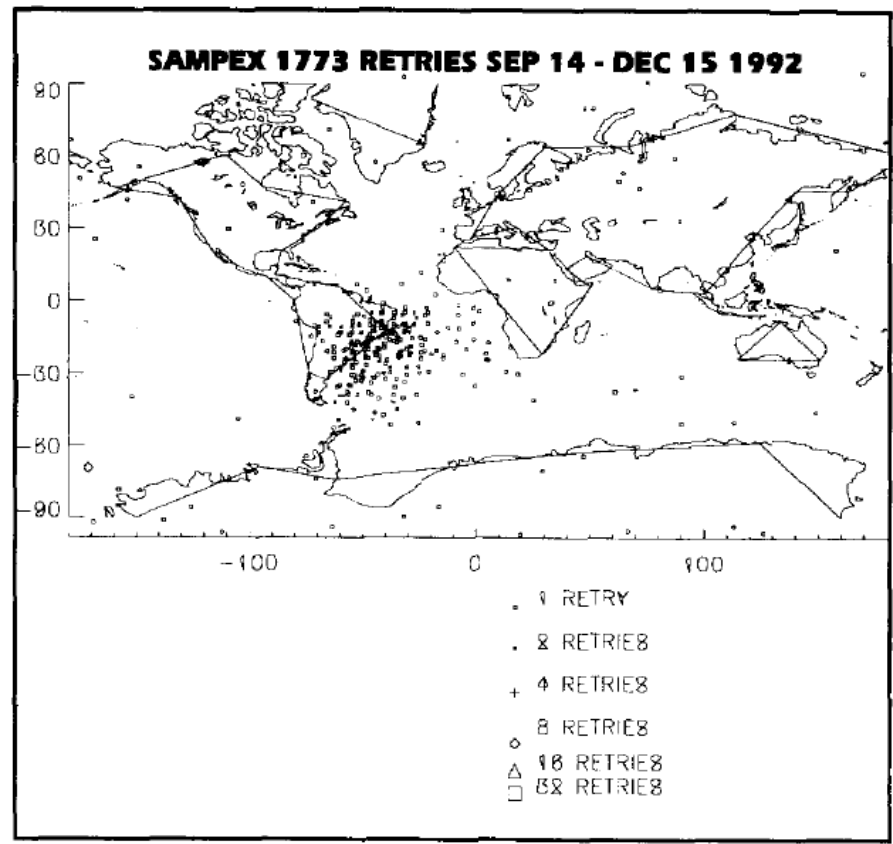

Figure 11 SAMPEX 1773 retries over Mercator projection

after K.A. LaBel, et al, "SEDS MIL-STD-1773 Fiber Optic Data Bus: Proton Irradiation Test Results and Spaceflight SEU Data," IEEE Transactions on Nuclear Science, Vol. 40, No. 6, Dec 1993



SEDS Technology: SSR

- **First NASA use of COTS SRAM as means of building a SSR.**
 - A Hitachi 32k x8 SRAM device was used and tested by the Aerospace Corporation for radiation tolerance prior to insertion.
 - The Air Force (P87 Mission) had flown this SSR design as an experiment previously.
 - In addition, fault tolerance (Hamming Code Error Detection and Correction (EDAC)) was included to deal with the expected single event upset (SEU) radiation hits.
- **The SSR was also the first use of surface mount technology (SMT) in a NASA spacecraft.**
 - SMT replaced through-hole mounting of devices to printed circuit boards (PCBs), thus allowing for two-sided PCB usage and more compact (physical) designs.
 - A detailed series of thermal vacuum and shock/vibration testing was performed on test coupons to determine “safe usage” and rules were developed for the SAMPEX products and subsequently used by other NASA missions.



P87-2 circa 1990

1st known spaceflight SSR

Air Force release pic from the P97-2 mission (aka Stacksat)

<http://www.thespacereview.com/article/2104/1>

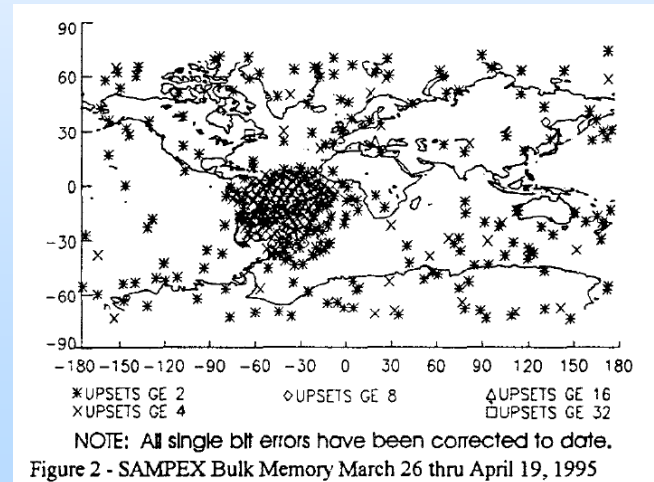

after C.M. Seidleck, et al, "Single Event Effect Flight Data Analysis of Multiple NASA Spacecraft and Experiments; Implications to Spacecraft Electrical Designs," IEEE Proceedings of the Third European Conference on Radiation and its Effects on Components and Systems, 18-22 Sept. 1995



SEDS Technology: COTS 32-bit Processor

- **The first use of a commercial 32-bit processor in a NASA spacecraft (INTEL 80386 and its peripheral support ICs).**
- **This drove a number of new features into and of itself:**
 - **Extensive radiation test campaign by GSFC and JPL on the 80386 processor family at the part level. This drove initial designs for fault tolerance.**
 - **A seven layer fault tolerant system that included:**
 - a watchdog processor,
 - software task monitors,
 - multi-day timeout, and more.
 - **Key Feature: the fault tolerance was based on dissimilar strings.**
 - A radiation hardened 80C86RH processor was used as a watchdog for the main processor
 - **A full system validation test under radiation exposure (i.e., an engineering model was taken to a heavy ion test facility along with the full ground system).**
 - Various chips were exposed sequentially.
 - Upsets/anomalies were noted and the system would utilize its fault tolerant features to recover.
 - A small number of unrecoverable events were noted and system workarounds were then designed in. This was teamwork at its best.
 - **First use of a commercial real-time operating system (RTOS): Ready Systems' Virtual Real-Time Executive (VRTX) and the "C" programming language.**
 - **Development and use of a deterministic software bus concept.**
 - **First true implementation of the Consultative Committee for Space Data Systems (CCSDS) "Blue Book" by NASA.**



Example 2: Mars Science Lander (MSL)

- **“Curiosity” Rover**
- **Landed on Mars in August, 2012, with planned ~700 day mission**
- **Currently still functioning, about 1700 days.**
- **Critical “7 minutes of terror” window during landing**
 - **No interaction with ground**
 - **Any problems (such as stochastic radiation events) would have to be handled automatically.**
 - **Good example of system where “second chance” approach could improve chances for success.**



**MSL Self Portrait
Mount Sharp, 2015
Courtesy NASA/JPL**



Synchronous Dynamic Random Access Memory (SDRAM): Common Memory Solution

- **MSL uses COTS SDRAMs in the Rover Compute Element (RCE)**
 - Many radiation-related error modes are known in SDRAMs
- **MSL was designed to mitigate these error modes**
 - Primarily through error detection and correction (EDAC)
 - Note: It is possible to mitigate ALL possible error modes in a SDRAM, using the IBM Chipkill™ technology, for example
 - Requires more complicated design
 - Difficult to fit into spacecraft SwaP
- **Similar devices are used in other NASA missions.**
 - Including parts from same wafer lot
- **In the MSL case, the devices were architecturally identical to devices used in the Juno mission**
 - Exception: Factory-set configuration options are different



Analysis for Juno helps MSL

- Juno spacecraft currently in orbit around Jupiter
 - Launched August 2011
 - Arrived at Jupiter July 2016
- Shortly after launch, Juno experienced single event functional interrupts (SEFIs)
- The SEFIs did not significantly impact Juno mission performance, but could they affect MSL?
- The data collected for Juno indicated a potential risk during MSL landing.
 - “Second chance” software approach was able to incorporate this information
 - Engineers also improved mitigation to this type of event before MSL launch

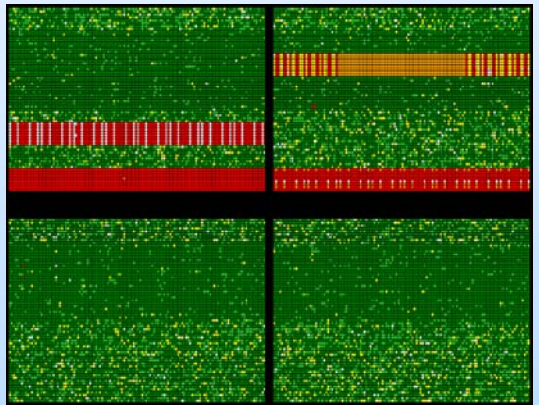

Error maps from data taken for Juno. SEFIs appear as bands and red dots (not visible)

Photo and figure courtesy of NASA/JPL



NASA's Changing Landscape

- **With NASA's new era of commercial providers and small space missions (i.e. CubeSats, etc...) other approaches are being considered to find more cost-effective approaches to meeting mission requirements.**
- **A few of the considerations for this emerging space include, but are not limited to:**
 - **Increased reliance on fault tolerance, architectural approaches, and even constellation spacecraft sparing,**
 - **Leverage on the improved defect reliability of high yield COTS, automotive, industrial, and medical grades of electronics,**
 - **Use of higher-assembly level testing,**
 - **Reliance on new tools for model-based mission assurance (MBMA), circuit simulation and verification, as well as physics of failure (PoF), and,**
 - **Improved communication on considerations, lessons learned and guidelines.**

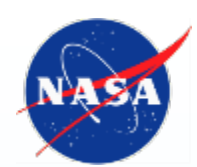

The Modern Approach to EEE Parts

- **The determination of acceptability for device usage is a complex trade space.**
 - Every engineer will “solve” a problem differently:
 - Ex., software versus hardware solutions.
- **The following chart illustrates a risk matrix approach for EEE parts based on:**
 - Environment exposure,
 - Mission lifetime, and,
 - Criticality of implemented function.
- **Notes:**
 - “COTS” implies any grade that is not space qualified and radiation hardened.
 - Level 1 and 2 refer to traditional space qualified EEE parts.

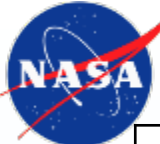

Notional EEE Parts Selection Factors

Criticality

| | | | |
|---------------|--------------------------------------------------------------------------------------------------------------|-------------------------------------------------------------------------------------------------------------|---------------------------------------------------------------------------------------------------------------|
| High | <p>Level 1 or 2 suggested. COTS upscreening/testing recommended. Fault tolerant designs for COTS.</p> | <p>Level 1 or 2, rad hard suggested. Full upscreening for COTS. Fault tolerant designs for COTS.</p> | <p>Level 1 or 2, rad hard recommended. Full upscreening for COTS. Fault tolerant designs for COTS.</p> |
| Medium | <p>COTS upscreening/testing recommended. Fault-tolerance suggested</p> | <p>COTS upscreening/testing recommended. Fault-tolerance recommended</p> | <p>Level 1 or 2, rad hard suggested. Full upscreening for COTS. Fault tolerant designs for COTS.</p> |
| Low | <p>COTS upscreening/testing optional. Do no harm (to others)</p> | <p>COTS upscreening/testing recommended. Fault-tolerance suggested. Do no harm (to others)</p> | <p>Rad hard suggested. COTS upscreening/testing recommended. Fault tolerance recommended</p> |
| | Low | Medium | High |

Environment/Lifetime



A Few Details on the “Matrix”

- **When to test:**
 - **“Optional”**
 - Implies that you might get away without this, but there’s residual risk.
 - **“Suggested”**
 - Implies that it is good idea to do this, and likely some risk if you don’t.
 - **“Recommended”**
 - Implies that this really should be done or you’ll definitely have some risk.
 - **Where just the item is listed (like “full upscreening for COTS”)**
 - This should be done to meet the criticality and environment/lifetime concerns.
- **The higher the level of risk acceptance by a mission, the higher the consideration for performing alternate assembly level testing versus traditional part level.**
- **All fault tolerance must be validated.**

Good mission planning identifies where on the matrix a EEE part lies.



Lessons Learned on COTS for Space (1)

- **In an ideal world (and given limitations of full state space coverage), you'd want to:**
 - **Test at the device level to provide input for fault tolerant design. And,**
 - **Test at the system level to validate design approaches**
 - **Possibly uncover additional fault modes (statistics of test coverage).**
- **Lots of folks are trying to do the 2nd and mistakenly calling it qualification when it's really "system validation" (with inherent risk)...**



Lessons Learned on COTS for Space (2)

- **Understanding the criticality of the application is the key to performing adequate testing and validation for risk management**
 - However, even “good” ground testing and designs can be surprised due to random/Markov nature of SEEs and challenges related to “completeness” nature of ground beam testing (coverage of targets and operating states)
- **Improving data sharing between not only NASA projects, but the greater aerospace industry leads to improved failure mode knowledge**
 - Required as input for designers and for efficient determination of additional data needed
 - MSL learned from Juno in a critical functionality area
 - What might have happened without it?



Summary

- **We have provided an overview of NASA COTS electronics usage.**
- **This has included**
 - **Background material on the challenge for COTS in space,**
 - **Two examples of successes with COTS in space,**
 - **A discussion of a recommended assurance approach, and,**
 - **A few lessons learned as takeaways.**